



Solar-Log Base Manual 6.x (Version 1.4)

Solar-Log Base

Publisher:

Solar-Log GmbH

Fuhrmannstr. 9

72351 Geislingen-Binsdorf

Germany

International support

Tel.: +49 (0)7428/4089-300

e-mail: info@solar-log.com

Contact: <https://www.solar-log.com>

Italy

Technical support: +39 0471 631032

France

Technical support: +33 97 7909708





Switzerland

Technical support: +41 565 355346

United States

Technical support: +1 203 702 7189

The Solar-Log™ Manual Orientation

Firmware 5	Solar-Log Base Manual
	Solar-Log Components Connection Manual
	Solar-Log Smart Energy Manual
Firmware 6	Solar-Log Base Manual
	Solar-Log Components Connection Manual 
	Solar-Log Smart Energy Manual 
	Solar-Log Meter Connection Manual 
	Solar-Log Feed-In Management Control Manual 

- Opened manual
- Further manuals

Table of Contents

1	Introduction.....	10
2	Safety information	11
2.1	Hazard Classes	11
3	Electric current.....	12
4	Package Contents and Installation	13
5	Solar-Log Base Connections	15
5.1	Top Connections Solar-Log Base.....	15
5.2	Solar-Log Base LEDs	16
5.3	Bottom Connections Solar-Log Base	17
6	Connector Assignments and Wiring	18
6.1	Notes on wiring the connections	18
6.2	General PIN Assignment	19
7	Solar-Log MOD I/O.....	20
7.1	Connecting the Solar-Log Base to the Solar-Log MOD I/O	20
7.2	PIN assignments Solar-Log MOD I/O general.....	21
7.3	LEDs Solar-Log MOD I/O	21
8	Solar-Log MOD 485	23
8.1	Connection Solar-Log Base - Solar-Log MOD 485.....	23
8.2	Top Connections Solar-Log MOD 485	24
8.3	Bottom Connections Solar-Log MOD 485.....	26
9	Combination option Solar-Log Base and expansion modules	27

9.1	Combination Solar-Log Base - Solar-Log MOD I/O and Solar-Log MOD 485.....	27
10	Connecting the inverters.....	29
10.1	Switch off the inverters and the Solar-Log Base.....	29
11	Components.....	30
11.1	Supported components.....	30
12	Other connections.....	31
12.1	USB.....	31
13	Installation.....	32
13.1	Connect the Solar-Log Base to a network / PC.....	32
13.2	Initial set up of the Solar-Log Base.....	32
13.3	Solar-Log™ replacement.....	33
13.4	Component replacement.....	34
13.5	Adding new components.....	34
14	Go to the Main Menu.....	35
14.1	Operating the Main Menu of the Solar-Log Base.....	38
14.1.1	Control elements.....	39
14.2	Explanations of the names in the main menu.....	40
14.2.1	Header bar.....	40
14.2.2	Left-side navigation menu.....	40
14.2.3	Configuration Page.....	40
14.2.4	Login Section Menu.....	41
14.2.5	Hide arrow.....	43
14.2.6	New Firmware.....	43
14.2.7	Installation Mode.....	45
14.3	Setting up of the Solar-Log™ with the configuration wizard.....	47
14.3.1	Manual Configuration of the Solar-Log Base.....	54
15	Main menu.....	55
15.1	Virtual LCD Display (VLC Display).....	55
15.2	Meaning of the symbols on the virtual LCD display (VLCD Display).....	56
15.3	Fault messages.....	57
15.4	Normal operation.....	57
15.5	Configuration.....	58
15.5.1	Network.....	58

15.5.2 Ethernet.....	59
15.5.3 Interface ETH 1	61
15.5.4 Interface ETH 2	62
15.5.5 Proxy.....	63
15.6 Internet.....	64
15.6.1 Portal	64
15.6.2 Export (only with license).....	66
15.7 Configuring connected devices	67
15.8 Device definition	68
15.8.1 Device definition with the extension module - Solar-Log MOD 485.....	71
15.8.2 Device Detection	72
15.8.3 Configuring devices	73
15.8.4 Generation Information on PAC Correction Factor	74
15.8.5 Configuring power meters.....	75
15.8.6 Configuring sensors.....	76
15.8.7 Configure the battery	76
15.8.8 Configuring AC-ELWA-E	77
15.8.9 Configuring IDM Heat Pumps.....	78
15.8.10 Configuring the Keba Power Charging Stations	79
15.8.11 Module Fields, Power Output and Descriptions	80
15.9 Configuring Plant Data	82
15.9.1 General.....	82
15.9.2 Plant groups.....	82
15.9.3 Graphic.....	83
15.9.4 Defining the PV plant's forecast data	83
16 Smart Energy	85
17 Feed-In Management.....	86
18 Direct Marketing.....	87
19 Data	88
19.1 Initial yield.....	88
19.2 Data correction.....	89
19.3 System backup	89
19.4 Backup.....	91
19.5 Reset.....	93
20 System Configuration.....	94
20.1 Access control.....	94

20.2	HTTPS	95
20.3	Language/Country/Time	96
20.4	Licenses	97
20.5	Firmware	99

21 Diagnostics Menu..... 101

21.1	Inverter Diagnostic.....	101
21.1.1	Inverter details	102
21.1.2	Tracker comparison.....	103
21.1.3	Module field comparison	104
21.2	Battery Diagnostic.....	105
21.2.1	Current Measurement Values	105
21.2.2	Charging History 1-Day	106
21.2.3	Charging History 7-Days.....	107
21.2.4	Balances	108
21.3	Accessing Event logs	109
21.4	Accessing Feed-In Management	110
21.4.1	Explanation of the Values in the Power Reduction Section.....	111
21.4.2	Explanation of the Symbols in the Feed-in power (% DC) column:.....	113
21.4.3	Explanation of the Values in the Reactive Power Reduction Section	114
21.4.4	Feed-balance section.....	116
21.4.5	PM History section	117
21.5	Accessing components.....	118
21.5.1	RS485 Bus Analysis	118
21.5.2	Expansion module - Solar-Log MOD I/O	120
21.5.3	Expansion module - Solar-Log MOD 485	122
21.5.4	SO Meter (only visible when connected).....	124
21.5.5	Wireless Package (only visible when activated).....	125
21.6	Access SCM Monitor (only visible when SCB installation mode / license active)	126
21.7	Smart Energy	127
21.7.1	Explanations of the terms.....	127
21.7.2	History Section	129
21.7.3	Simulation Section	131
21.8	Accessing Support.....	133

22 Yield Data Menu 134

22.1	Current values	134
22.1.1	Energy flow	136
22.1.2	Table	137
22.2	Production	138
22.2.1	Day view	139
22.2.2	Month view	141
22.2.3	Year view	143
22.2.4	Total view	144
22.3	Consumption (only when consumption meters are connected)	145
22.4	Balances	151
22.4.1	Day balance	153

22.4.2	Month balance.....	154
22.4.3	Year balance	155
22.4.4	Total balance	156
22.5	Sensor (only when connected).....	157

23 Display Definition 158

23.1	Generation Display Controls	158
23.2	Values	159
23.3	Status.....	160
23.4	Configuration.....	161
23.5	Installation	162
23.6	QR Code	163
23.7	Solar-Log Base LEDs	164

24 Faults 165

24.1	Error messages.....	165
24.1.1	Fault messages time	165
24.1.2	Fault messages Internet.....	165
24.1.3	Fault messages Feed-in Management.....	166
24.1.4	Portal Transfer Fault messages.....	166

25 Cleaning and care..... 167

25.1	Cleaning tips	167
25.2	Care tips	167

26 Disposal 168

27 Appendix 169

27.1	Internet ports	169
27.2	Connection examples for ripple control receivers.....	170
27.2.1	Variation with 4 relays (ENBW >100kWp).....	171
27.2.2	Variation with two relays.....	173
27.2.3	Variation with three relays.....	175
27.2.4	Variation with 5 relays (including emergency stop).....	177
27.3	Digital Interfaces	179
27.3.1	Modbus TCP	179
27.3.2	Open JSON Interfaces.....	181

28 Dimensions 183

29 List of Figures 184

1 Introduction

This manual is intended for use by solar energy technicians and professional electricians, as well as Solar-Log Base users. The installation and commissioning of components may only to be performed by properly trained specialists. Refer to Chapter 2 "Safety information" for more information.

The wiring of the individual additional devices is described in detail in the component connection manual. To be found in the [download area](#) of our homepage.

The Solar-Log™ must only be used by persons who have fully read and understood the manual before installing, operating and/or servicing the device.

Our product documentation is being constantly updated and expanded.
The current versions of the documents can be downloaded from our website:
<https://www.solar-log.com/en/support/download-area>.

The descriptions in this manual refer to firmware version 6.x

Note



Firmware:

Because of eventual factors (storage at the distributor, etc.), it is possible that the firmware version of the Solar-Log™ is not up to date at the time of delivery. It is therefore recommended to compare the firmware with the current version on our homepage and update it if necessary before installing the SolarLog™ device. Please use the update function of the Solar-Log™ configuration wizard for this purpose.

(See chapter: "Setting up of the Solar-Log™ with the configuration wizard")

2 Safety information

In order to protect people, the device itself, and other equipment, please pay attention to the following before handling the product:

- the content of this manual,
- the safety information,
- the warning signs and type plates attached to the product.

Note:

All the actions described in this manual for wiring and working on the individual components must be carried out only by specially trained electricians. All repairs should only be carried out by similarly trained personnel, or by the manufacturers themselves.

Solar-Log GmbH is not liable for any personal injuries, property damages and system malfunctions and their consequences which result from not adhering to the product documentation.

2.1 Hazard Classes

The safety instructions in this document are represented with standard signs and symbols. Two classes of risk are identified, depending on their probability of occurrence and the seriousness of their consequences.

Danger



Indicates an imminently hazardous situation to life
Non-compliance with this warning can lead to severe and irreversible injuries or death

Caution



Indicates an imminently hazardous situation to people, or a risk of material damage
Non-compliance with this warning can lead to irreversible injuries or to material damage.

3 Electric current

Danger



Risk of death by electric shock if inverters are opened.

Never open the inverter housing when the inverter is connected to power.

Refer to Switching inverters off.

Always read the installation and safety instructions given in the manual for the corresponding inverter.

Danger



Danger of death if there is condensation in the power supply unit when started!

Condensation can occur if the power supply unit is moved directly from a cold environment to a warm environment.

Wait until the temperatures have equalized before doing this.

Caution



Damage to the electrical components in inverters and on interface cards due to electrostatic discharge.

Avoid contact with component connections and plug contacts.

Before picking up the component, ground yourself by holding the protective conductor (PE) or the unpainted part of the inverter housing.

Caution



Damage to the electrical components of the Solar-Log™ due to the wiring of the Solar-Log™!

Disconnect the Solar-Log™ from the power supply.

Caution



Risk of electric shock.

Do not use the unit if the housing of the external power supply unit is damaged. A damaged power supply unit must be replaced by one of the same type in order to avoid danger.

Caution



The Solar-Log™ may only be used indoors or enclosed spaces.

The device has the protection class IP20.

4 Package Contents and Installation

Check the package contents before proceeding to assembly and installation.

Report any damage or missing parts to the forwarding agent and dealer immediately.

The device is produced according to protection class IP20 and is intended only for installation in interior areas that are dry and dust-free.

It can be mounted on the wall (see illustration below) or on a top-hat rail (refer to the Solar-Log™ dimensions in chapter 23). Power can come from a DIN rail power supply or a 24V power supply with an adapter.

Note



Please note that a power supply is not included in the package contents.

Note



Power supply optional *

Depending on output voltage (24V DC (+5%)), if required 12V DC (+5%), observe component requirement.

Note



We recommend using the Solar-Log™ power supply (Art.N.: 256226).

* The Solar-Log Base may only be supplied with 12V DC in conjunction with the special Piggy Back (Art 220020). Please also note the power supply of sensor boxes via the bus.

Wall mounting

For wall mounting, extend the snap-fit tabs on the bottom of the device and attach it to the wall with suitable accessories.



Fig.: Solar-Log Base without extended snap-fit tabs



Fig.: Solar-Log Base with extended snap-fit tabs

5 Solar-Log Base Connections

5.1 Top Connections Solar-Log Base

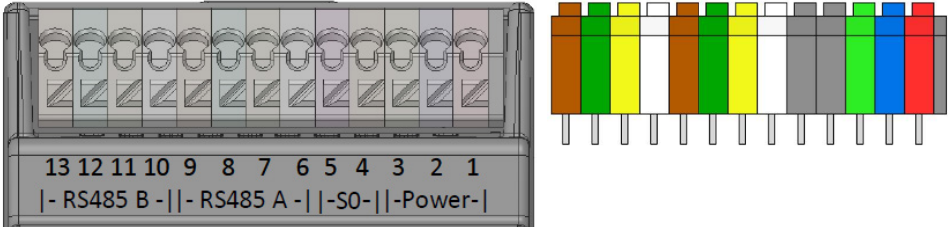

Fig.: Solar-Log Base connections - 2 x RS485 (A and B) or 1 x RS422 - colored PIN connection on the device

Solar-Log Base Top connections

2 x RS485 or 1 x RS422	Connection for accessories according to component connection manual.
1 x S0	Connection for S0 meter
1 x Power	Connection pins for the power supply

Technical Data

Nominal voltage*	24V DC (+-5%), if required 12V DC (+-5%)
Cable cross-section	<ul style="list-style-type: none"> ▶ 0.14 to 1.0 mm² with ferrules. (Ferrules should be used with stranded wire.) ▶ 0.2 to 1.5 mm² with stranded wire ▶ 0.2 to 1.5 mm² with solid wire
Power consumption	< 0.5W

Note



The software automatically switches between the RS485 and the RS422 interface assignment.

*For installations in the US market, use only NEC Class 2 power supplies.

Color Legend

Color	Meaning
Red	Power supply
Blue	GND
Light green	Functional ground
Gray	Input S0
White	Input (Data+, TX+/RX+, A-)
Yellow	24 V / (12 V)*
Olive green	GND*
Brown	Output (Data-, TX-/RX-, B-)

* Power connection for external components.

5.2 Solar-Log Base LEDs

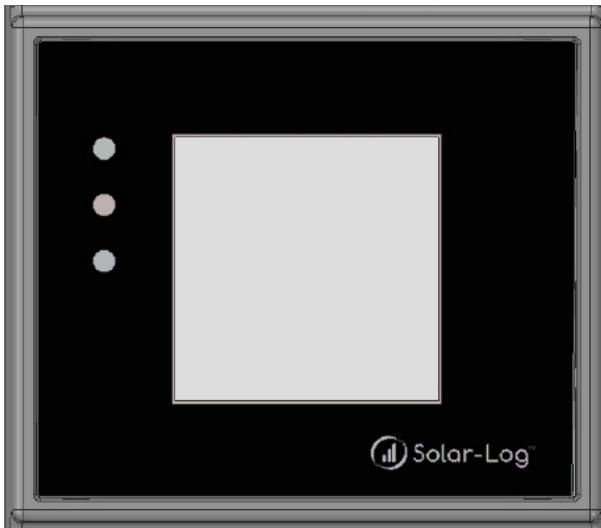

Fig.: Display with LEDs

Depending on the operating state, the LEDs can be lit up continuously in different colors.

Normal operation

Solar-Log Base - LEDs (from top to bottom)

Name	Color	Meaning
Power (top)	is green	Power supply available
Power (top)	blinks red	The installation mode has expired / missing licenses.
Internet (middle)	is red	No Internet connection. ▶ Check the network cables.
Internet (middle)	is orange	DNS failure.
Internet (middle)	is green	Internet connection available
Components (bottom)	is red	Connection lost to at least one component.
Components (bottom)	is green	Normal operation. Connection established to the components. (The LED is also green when there is no solar irradiation, e.g. night shut-off)

5.3 Bottom Connections Solar-Log Base

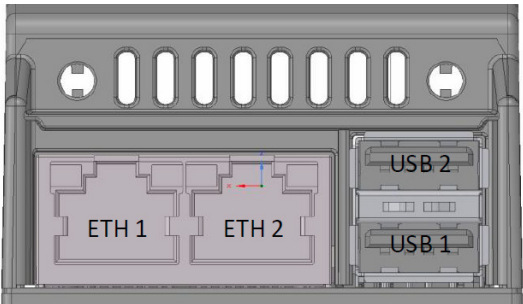

Fig.: Bottom Connections Solar-Log Base

Top of the Solar-Log Base

2 x USB	USB connection. Suitable for USB sticks. Not suitable for a connection to a PC / laptop.
2 x Network	Ethernet network interface, 10/100 Mbit 1x Internal 1x External

Note



The USB connection can only be used for USB sticks and not for a direct PC or laptop connection.

6 Connector Assignments and Wiring

The following connection cables are required as needed:

- To connect a router, you need a network cable with the appropriate length.
- If you want to connect the Solar-Log™ directly to your PC or laptop, you need to use a crossover cable.
- Cable to connect the Solar-Log™ to an inverter.
- Sets of prefabricated cables for particular inverters are available from our [Solar-Log™-Shop](#). The length of these cable sets is 3 m.
- If you want to connect several inverters to Solar-Log™, you need suitable cables and connectors to connect the inverters to each other.
- When wiring with CAT cables, the twisted pair of wires should be used.

6.1 Notes on wiring the connections

The wiring of the inverters and accessories needs to be carried out with the greatest care and attention. The most frequent source of errors when installing the Solar-Log™ is faulty wiring.

We therefore strongly recommend:

- Wiring with high quality cables.
For example: LIYCY $\geq 0.14\text{mm}^2$ or Cat 6/7 SSTP.
- Refer to the manufacturer's specifications in regard to UV resistance and mounting type when wiring in outside areas.
- A larger cable diameter is recommended for longer distances.
- Use ferrules with flexible wires
- Twist the corresponding wire pairs.
- Twist the shielding.
- Wire from PIN 1 to PIN x.
- Wire from light to dark.

Note



All Solar-Log Base devices are terminated ex works. An installation of the Solar-Log base devices can therefore only take place at the beginning or end of a bus.

6.2 General PIN Assignment

Pin assignment	Power	S ₀ IN	RS485 A/B	RS422
PIN	Assignment	-	-	-
1 (red)	V _{in} 24 V _{DC} / (12 V _{DC})	-	-	-
2 (blue)	Ground	-	-	-
3 (lime green)	Functional earth	-	-	-
4 (grey)	-	S ₀ IN+	-	-
5 (grey)	-	S ₀ IN-	-	-
6 (white)	-	-	Data+	T/RX+
7 (yellow)	-	-	24 V / (12V)	24 V / (12V)
8 (olive green)	-	-	GND	GND
9 (brown)	-	-	Data-	T/RX-
10 (white)	-	-	Data+	R/TX+
11 (yellow)	-	-	24 V / (12V)	-
12 (olive green)	-	-	GND	-
13 (brown)	-	-	Data-	R/TX-

Note



If inverters that use the RS422 connection are connected to this interface (e.g. Fronius, AEG, Riello), then it is not possible to connect accessories such as sensors or meters to this bus.

Note



The software automatically switches between the RS485 and the RS422 interface assignment.

7 Solar-Log MOD I/O

7.1 Connecting the Solar-Log Base to the Solar-Log MOD I/O

To establish a connection between the Solar-Log Base and the Solar-Log MOD I/O, use the enclosed bus connectors. (See illustrations below)

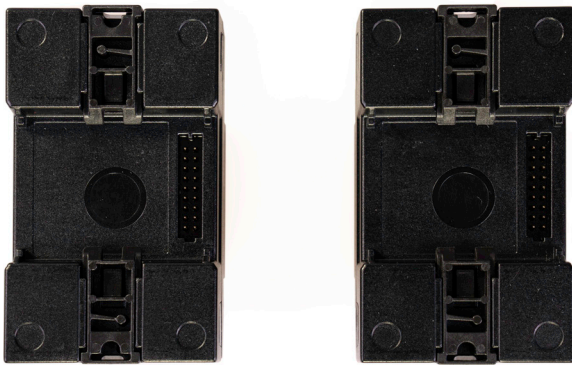

Fig.: Solar-Log Base / Solar-Log MOD I/O without a bus connector

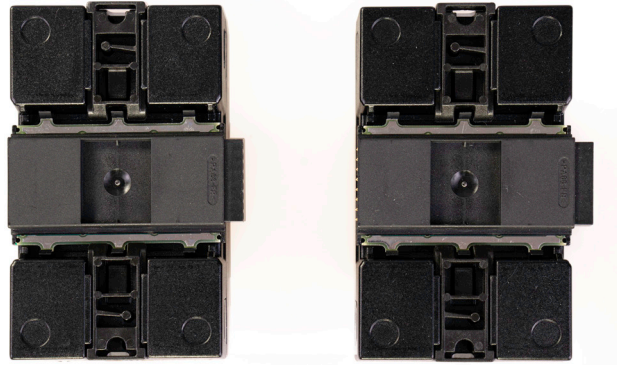

Fig.: Solar-Log Base / Solar-Log MOD I/O with a bus connector

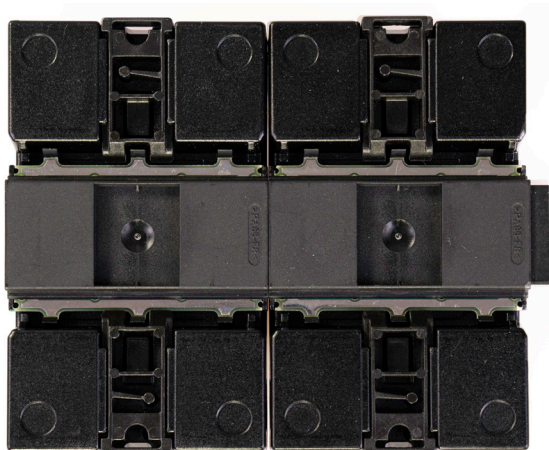

Fig.: Solar-Log Base / Solar-Log MOD I/O with a bus connector joined together.

Important!



Disconnect the power from the Solar-Log Base before installing the Solar-Log MOD I/O module!

Note



Only one Solar-Log MOD I/O can be connected to the Solar-Log Base.

7.2 PIN assignments Solar-Log MOD I/O general

PM+

Pin	Assignment	Description
1	+24 V / (12V)	Control voltage for active power control.
2	D_IN_1	Control input 1
3	D_IN_2	Control input 2
4	D_IN_3	Control input 3
5	D_IN_4	Control input 4
6	+24 V / (12V)	Control voltage for reactive power reduction.

Note



The Solar-Log MOD I/O module will be automatically detected after the Solar-Log Base has been restarted. With the first firmware version of the Solar-Log MOD I/O, the connection to a ripple control receiver can be configured.

Refer to Chapter "Remote controlled active power reduction (only with Solar-Log MOD I/O)".

Note



In the case of wall installation, be sure to use a piece of rail to stabilize the bus connectors. In this regard, it should be ensured that a TH 35 / 7.5 or TH 35 / 15 rail in accordance with IEC/EN 60715 is used.

7.3 LEDs Solar-Log MOD I/O

The color of the LEDs and whether they are blinking or not indicates the operation status (refer to the table below).

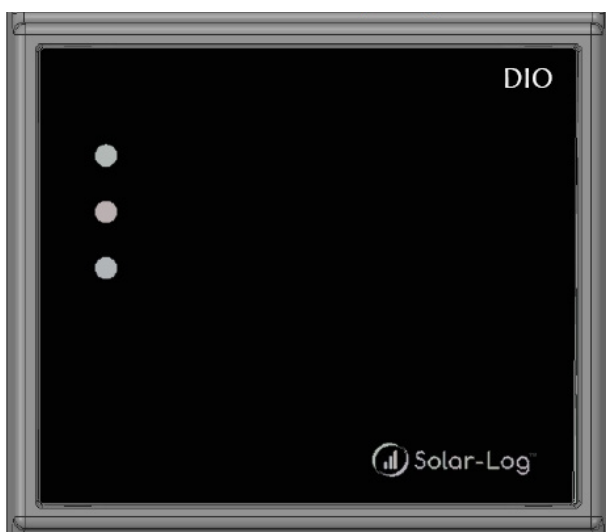

Fig.: Display of the Solar-Log MOD I/O with LEDs

Table LEDs - Solar-Log MOD I/O

Solar-Log MOD I/O - LEDs (from top to bottom)

Name	Color	Meaning
Power (top)	green	The Solar-Log MOD I/O is receiving power.
Communication (middle)	blinking / lights up green	Communication with the Solar-Log MOD I/O has been established.
Operating status (bottom)	red	The Solar-Log MOD I/O is starting.
Operating status (bottom)	orange	A firmware is being updated.
Operating status (bottom)	green	The Solar-Log MOD I/O is ready for operation.
		Important: Data is only read in the operational mode.

8 Solar-Log MOD 485

8.1 Connection Solar-Log Base - Solar-Log MOD 485

To establish a connection between the Solar-Log Base and the Solar-Log MOD 485, use the enclosed bus connectors. (See illustrations below)

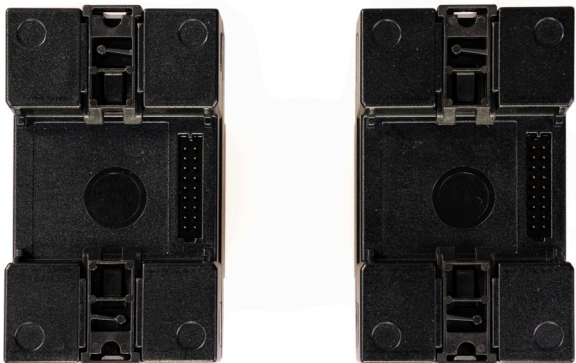

Fig.: Solar-Log Base / Solar-Log MOD 485 without a bus connector

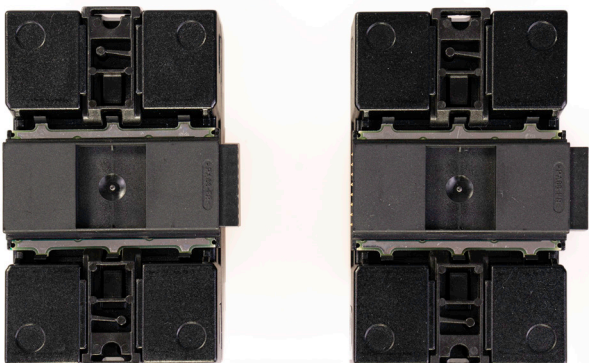

Fig.: Solar-Log Base / Solar-Log MOD 485 with a bus connector

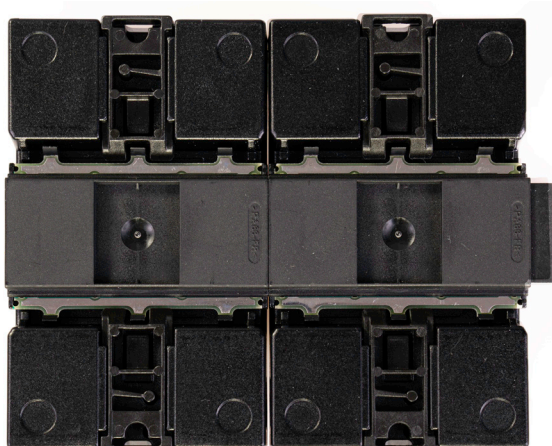

Fig.: Solar-Log Base / Solar-Log MOD 485 with a bus connector joined together.

Important!



Disconnect the power from the Solar-Log Base before installing the Solar-Log MOD 485 module!

Technical data

Device voltage	24V (+-5 %), if required 12V (+-5 %)
Cable cross-section	<ul style="list-style-type: none"> ▶ Solid conductor: 0.2 to 1.5 mm² ▶ Fine-stranded conductor: 0.2 to 1.5 mm² ▶ With ferrules: 0.14 to 1.0 mm² (ferrules should be used with fine-stranded conductors).
Stripping length	8.5 - 9.5 mm, with ferrules ≤ 6 mm
Device power	2.4 W (Solar-Log Base) with additional modules higher
Dimensions (WxHxD) in mm	53,6 x 89,7 x 60,3

8.2 Top Connections Solar-Log MOD 485

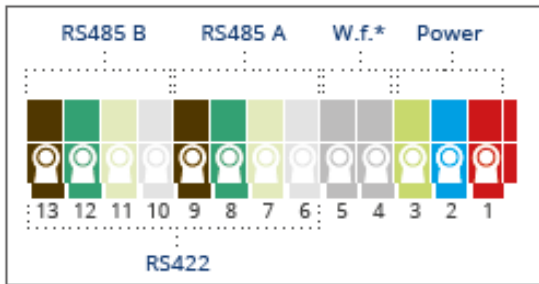

Fig.: Solar-Log MOD 485 connections - 2 x RS485 (A and B) or 1 x RS422
*Without function

Solar-Log MOD 485 Top connections

2 x RS485 or 1 x RS422	Connection for accessories according to component connection manual.
1 x Power	Connection pins for power supply

Note



The software automatically switches between the RS485 and the RS422 interface assignment.

Note



Only one Solar-Log MOD 485 can be connected to the Solar-Log Base.

Color Legend

Color	Meaning
Red	Power supply
Blue	GND
Light green	Functional ground
White	Input (Data+, TX+/RX+, A+)
Yellow	24 V / (12V)*
Olive green	GND*
Brown	Output (Data-, TX-/RX-, B-)

*Power connection for external components.

PIN assignment top

PIN assignment	RS485-A/B	RS422	Power
Pin	Assignment	-	
1 (Red)	-	-	$V_{in} 24 V_{DC} / (12 V_{DC})$
2 (Blue)	-	-	Ground
3 (Light green)	-	-	Functional ground
4 (Gray)	-	-	
5 (Gray)	-	-	
6 (White)	Data+	T/RX +	
7 (Yellow)	24 V / (12V)	24 V / (12V)	
8 (Olive green)	GND	GND	
9 (Brown)	Data -	T/RX -	
10 (White)	Data +	R/TX +	
11 (Yellow)	24 V / (12V)	-	
12 (Olive green)	GND	-	
13 (Brown)	Data-	R/TX -	

8.3 Bottom Connections Solar-Log MOD 485

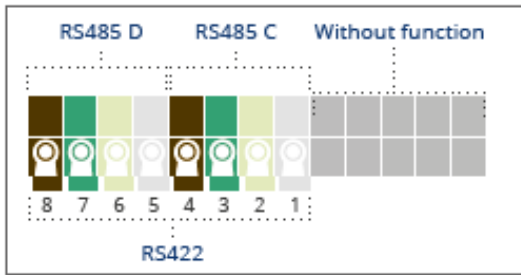

Fig.: Solar-Log MOD 485 connections - bottom side

Solar-Log MOD 485 - Bottom side

2 x RS485 or 1 x RS422

Connection for accessories according to component connection manual.

Note



For wall mounting, it is essential to use a piece of top-hat rail to stabilize the bus connectors. In any case, it should be ensured that a top-hat rail TH 35 / 7.5 or TH 35 / 15 according to IEC/EN 60715 is used.

PIN assignment bottom

PIN assignment	RS485-C/D	RS422
Pin	Assignment	-
1 (Red)	Data+	T/RX+
2 (Blue)	24 V / (12 V)	24 V / (12 V)
3 (Light green)	Ground / GND	Ground / GND
4 (Gray)	Data-	T/RX-
5 (Gray)	Data+	T/RX+
6 (White)	24 V / (12 V)	-
7 (Yellow)	Ground / GND	-
8 (Olive green)	Data-	T/RX-

9 Combination option Solar-Log Base and expansion modules

9.1 Combination Solar-Log Base - Solar-Log MOD I/O and Solar-Log MOD 485

With the Solar-Log MOD I/O it is possible to use the entire range of feed-in management control, while with the Solar-Log MOD 485 there is the possibility of interface expansion (see chapter Solar-Log MOD 485 above). The combination allows the complete range of functions of the modules to be used for the Solar-Log Base. (See the figures below)



Fig.: Combination Solar-Log Base with Solar-Log MOD I/O and Solar-Log MOD 485 (Connected - front side)



Fig.: Combination Solar-Log Base with Solar-Log MOD I/O and Solar-Log MOD 485 (Connected - back side)

Note



Only one Solar-Log MOD I/O and one Solar-Log MOD 485 can be connected to the Solar-Log Base at a time.

- ▶ This results in the combination option shown above.

10 Connecting the inverters

As each inverter manufacturer uses different wiring connections and connectors, the corresponding data cables must be adapted correctly.

- See Chapter 6 „Connector Assignments and Wiring“ for terminal block connector wiring diagrams for the connection to the Solar-Log™
- Please refer to the Component Connection Manual when connecting inverters supported by the Solar-Log™. (Download from <https://www.solar-log.com/en/support/download-area/manuals>)

Note



Solar-Log GmbH supplies suitable connection cables for most inverter manufacturers.

Always read the manufacturer-specific instructions for connecting the data cable. You will find these instructions in the manufacturer's documentation.

However, when assigning the inverter wiring on the Solar-Log™, follow the instructions in this manual to ensure that the inverters are correctly detected by the Solar-Log™.

Danger



There is a risk of death by electric shock if inverters are opened.

Never open the inverter housing when the inverter is connected to power.

See chapter "Switching inverters off."

Always read the installation and safety instructions given in the manual for the corresponding inverter.

10.1 Switch off the inverters and the Solar-Log Base.

Switching inverters off

Before making a cable connection between the Solar-Log and the connections inside the inverter and before installing an interface card in the inverter, always turn off all of the inverters first.

To do this, read the manufacturer's documentation for the inverter, and proceed as follows:

- Disconnect the AC side.
- Disconnect the DC side.
- Wait at least 5 minutes until the condensers in the inverters have discharged.

Switch off the Solar-Log Base.

- Disconnect the Solar-Log Base from the power supply.

11 Components

11.1 Supported components

Below you will find a list of the components supported by the Solar-Log Base:

- Battery storage systems
- Charging stations
- Heat Pumps
- Heating rods
- Hybrid systems
- Large displays
- Meters
- Pyranometer
- Sensor Box Basic as well as Professional and Professional Plus
- Smart Plugs
- Solar-Log™ Smart Relay Box

For connection, settings, and notes, please refer to [the component connection manual](#) downloadable from our homepage.

12 Other connections

12.1 USB

The Solar-Log Base comes with two USB connections. This USB connection can only be used for USB sticks and not, for example, for a direct PC or laptop connection.

Note



When a USB stick is connected, the Solar-Log™ automatically saves a backup in the backup folder. A maximum of 10 backup files are saved in the directory. Older backup files are automatically deleted.

The backup is saved on the USB stick in the directory /Backup with the following file names:

- solarlog_backup_YYMMDD.dat:
YYMMDD = year, month and day - each two digits, e.g.
230223 is then 23 February 2023.

13 Installation

The Solar-Log Base has an integrated web server, which contains all the software necessary for operation and configuration.

No additional software needs to be installed on the PC to access the Solar-Log Base.

A common web browser with JavaScript enabled is required.

We recommend using the current version of Mozilla's Firefox, Google's Chrome or Microsoft's Edge.

To run the web browser, a network connection is required between the PC or laptop and Solar-Log Base, and Solar-Log Base must be up and running. It is required to have the DHCP server enabled on the router.

13.1 Connect the Solar-Log Base to a network / PC.

The Solar-Log Base is equipped with two standard Ethernet RJ45 sockets, which can be connected through any commercially available network cable. Speeds of 10 Mbit and 100 Mbit are supported.

In general, any PC networking technology can be used for connecting the Solar-Log Base. The following technologies are available:

- Connection through an Internet router:
Ethernet RJ45 network cable.
- Direct cable connection from the PC to the Solar-Log Base:
Ethernet RJ45 network patch cable.

If the Solar-Log Base is operated via a router, ensure that the necessary ports have been activated (see Chapter „Internet-Ports“).

Note



The Solar-Log Base has DHCP activated by default to be able to establish a connection when connected to a router with its DHCP server enabled.

13.2 Initial set up of the Solar-Log Base

The complete configuration of the Solar-Log Base can be done via the PC/laptop or via a tablet or smartphone.

Requirements

- All cables and accessories (if any) have been connected to the Solar-Log™.
- The Solar-Log Base is connected to an Internet router.
- The DHCP server is enabled on the Internet router.

or

- The DHCP server is enabled when connecting directly to the Solar-Log Base with a PC.
(We recommend a crossover network cable here.)

Note

Please also be sure to carry out a system backup on a harddrive after initial start-up. We recommend regular data back-ups and also that a system back-up should be carried out if changes are made in the configuration of the plant.

To carry out a backup and system backup, proceed as follows:

Carrying out a backup:

Access the [Configuration | Data | Backup](#) menu item on the Solar-Log™ in the web interface.

Then click the “Prepare” button in the “Save data backup on harddrive” area. This may take some time. Confirm with “OK”.

You can now save the file in any folder that you choose on the harddrive by selecting “Download”.

Carrying out a system backup:

Access the [Configuration | Data | System Backup](#) menu item on the Solar-Log™ in the web interface. Then click the “Prepare” button in the “Save system settings to hard disk” area. Save to the hard disk. You can now save the file in any folder that you choose on the hard disk by selecting “Download”.

13.3 Solar-Log™ replacement

If the Solar-Log™ is to be replaced soon, a system and data back-up of the old device should be made beforehand. To ensure that data is transferred properly, the sequence of interfaces must be identical on the old device and replacement device. Subsequently, the previously created system and data back-up is simply restored.

Note

When restoring the system and data back-up, always restore the system back-up first.

To restore a system and data back-up to the Solar-Log™, the following steps are necessary:

Restoring the system backup:

Access the [Configuration | Data | System Backup](#) menu item on the Solar-Log™ in the web interface.

Click the “Search” button in the “Restore system settings from hard disk” area. Search for the solarlog_config.dat file and select it. This is transferred to the Solar-Log™ by clicking the “Upload” button.

Restoring the data backup:

Access the [Configuration | Data | Backup](#) menu item on the Solar-Log™ in the web interface. Click the “Search” button in the “Restore data backup from harddrive” area. Search for the solarlog_backup.dat file and select it.

This is transferred to the Solar-Log™ by clicking the “Upload” button.

13.4 Component replacement

To ensure that data recording can continue to function correctly when a device is replaced, the device to be replaced must be installed with exactly the same sequence and at the same interface as the old device. Subsequently, the previously created system back-up is simply restored.

To restore a system back-up to the Solar-Log™, the following steps are necessary:

Restoring the system backup:

Access the [Configuration | Data | System Backup](#) menu item on the Solar-Log™ in the web interface.

Click the “Search” button in the “Restore system settings from hard disk” area. Search for the solarlog_config.dat file and select it. This is transferred to the Solar-Log™ by clicking the “Upload” button.

13.5 Adding new components

To ensure correct data recording when adding new components, these must be added at a free interface.

After installation, the component must be added using [Configuration | Devices | Definition](#) for each interface assignment and then recognized using [Configuration | Devices | Detection](#).

14 Go to the Main Menu.

The various options to open the main menu of the Solar-Log Base are listed below:

Device URL

- Start the web browser.
- Enter `http://solar-log` in the address bar and press the ENTER key.
- The main menu of the Solar-Log™ is displayed.

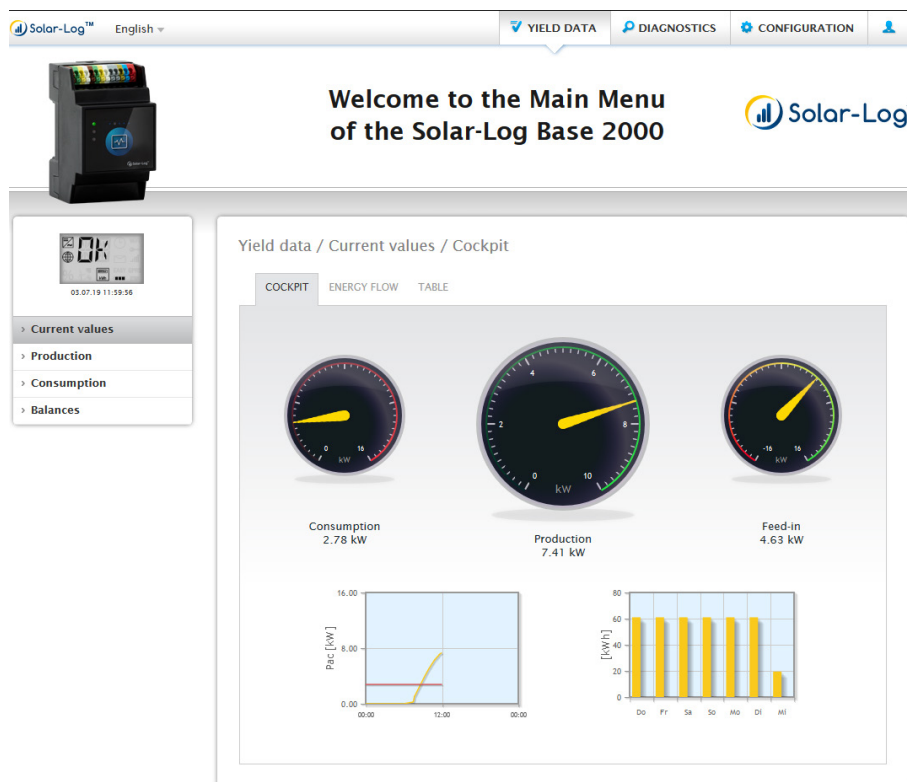

Fig.: Main menu of the Solar-Log Base 2000

Alternatively, the Solar-Log™ can also be accessed as follows:

IP address from an automatic IP range:

- Start the web browser.
- Enter `http://169.254.wx.yz` in the address bar and press the ENTER key:
Here wxyz stands for the last 4 digits from serial number of the Solar-Log Base. The serial number is located on the service (see left device side).
- The main menu of the Solar-Log Base is displayed.

IP address that was entered during the initial configuration

- Start the web browser.
- Enter IP address from the **Initial Configuration** in the address bar and press the ENTER key.
- The main menu of the Solar-Log Base is displayed.

Go to the Main Menu.

Device URL when there are several Solar-Log™ devices on the network

- Start the web browser.
- Enter `http://solar-log-wxyz` in the address bar and press the ENTER key:
Here wxyz stands for the last 4 digits from serial number of the Solar-Log Base.
The serial number is located on the service (see left device side).
- The main menu of the Solar-Log Base is displayed.

Note



All Apple user have to use "169.254.wx.yz" to access the Solar-Log Base.

Define the password.

If no password has been defined, the a security notice is displayed in the following window.



Fig.: Pop-up window with security information

Click on "Yes" here to directly define a user password. The following configuration page appears:

Configuration / System / Access control

ACCESS CONTROL HTTPS LANGUAGE/COUNTRY/TIME LICENCES FIRMWARE

Browser access control

Password required for user access Deactivated

User password

Repetition

Password required for installer access Deactivated

Installer password

Repetition

Password required for installer/PM access Deactivated

Installer password

Repetition

Public JSON interface

Activate Activated

CANCEL SAVE

Fig.: Configuration page "Access control"

In the Access protection for the browser section, the user password can be activated and defined. Click on "save" after the defining the password.

Set password later (not recommended)

It is possible to define the user password later by clicking on "No" or by clicking on "No" after checking the box "I am aware of the security risks." Close the "Do not show this dialog automatically any more" window. Check this box to skip this dialog. Otherwise, the security warning opens each time the web interface is accessed.

As a reminder to define a password, a small red triangle appears in the top right corner. Click on this icon at any time to define the user password. Once a password has been defined, the triangle disappears.

Go to the Main Menu.

14.1 Operating the Main Menu of the Solar-Log Base

The main menu of the Solar-Log Base functions like a website and is divided into four main sections:

- Header bar (A)
- Left navigation (B)
- Tab (C)
- Configuration page (D)

Various control elements are used. (See the explanation below).

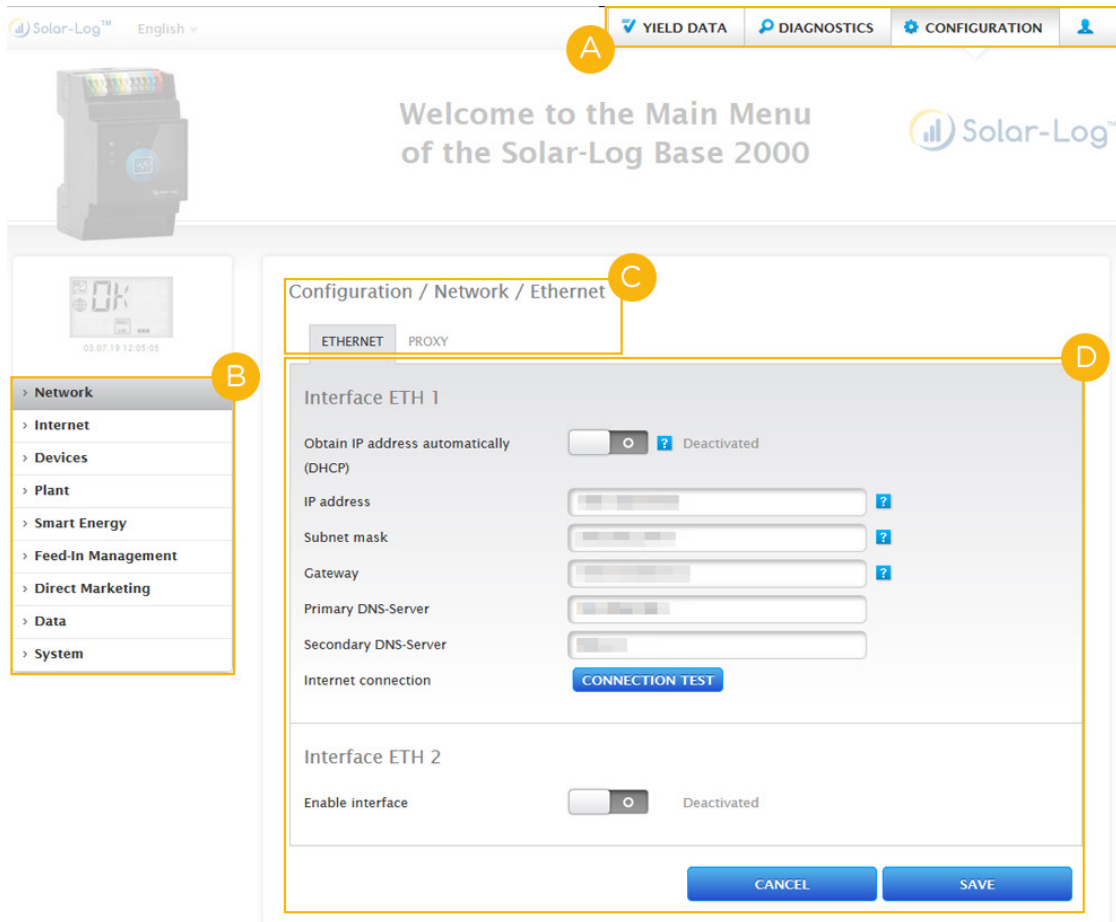

Fig.: Structure of the Solar-Log Base's Main Menu

14.1.1 Control elements

The following control elements are used:

Control elements







Control element	Meaning
	Text field
	Text field with incorrect or missing entry.
	Drop-down selection list
	Switch deactivated and activated
	The question mark boxes display additional information
	Check boxes Several boxes can be selected at one time
	Command buttons for various functions

Fig.: Control elements

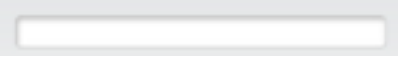
14.2 Explanations of the names in the main menu.

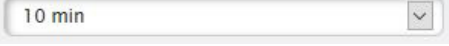
14.2.1 Header bar

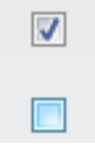
The header contains four main sections:

- **Login symbol** (👤):
Clicking on the login symbol, for example, allows you to access the info center or assistant.
- **Configuration:**
Here you can change the device settings as required.
- **Diagnostics:**
Diagnostics allows you to view a summary of the device information and to create a diagnostic report.
- **Yield data:**
Yield data allows you to view the current plant yields and the system information.

Note



All of the points are described below in the chapters:

- Login Section Menu
- Configuration Menu
- Diagnostics Menu
- Yield Data Menu.

14.2.2 Left-side navigation menu

Depending on the tab selected, you can access additional functions from the navigation menu (left-side).

Tabs

Additional configuration sections appear according to the function selected.

14.2.3 Configuration Page

Here you have the option to make any necessary modifications to the configuration, to create back or to reset the device.

14.2.4 Login Section Menu

You can enter a password protected section by clicking on the log in button (to the right of the confirmation in the web interface) and entering your user and password. There is a gray line below the login button that indicates if you are logged in and with which user level. (Refer to the [Access Control](#) section for more information)

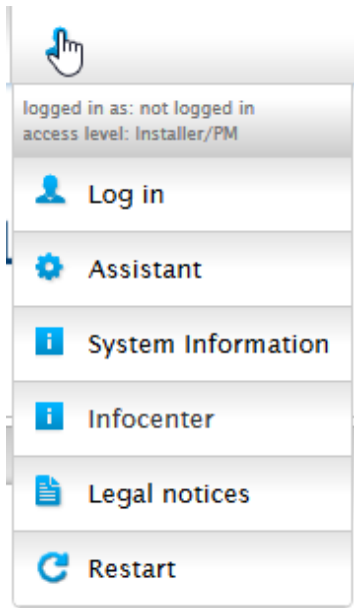

Fig.: Log in button with selection box

Additional points below the login symbol:

- Assistant
- System Information
- Info Center
- Important Legal Information
- Restart

Assistant

The configuration wizard can be started directly from here.

System Information

The following information can be viewed from system information:

About the Solar-Log™:

- Model
- Serial number
- Firmware version

Plant data:

- Plant size

Detected devices (depending on what devices are connected):

- Battery
- Hybrid System
- Sensor
- Inverter
- Meter

Go to the Main Menu.

Data transfers:

- Portal transfer - Last transfer with time and date and status message (in the example: OK)
- FTP/FTPS Export - Last transfer with time and date and status message (in the example: OK)

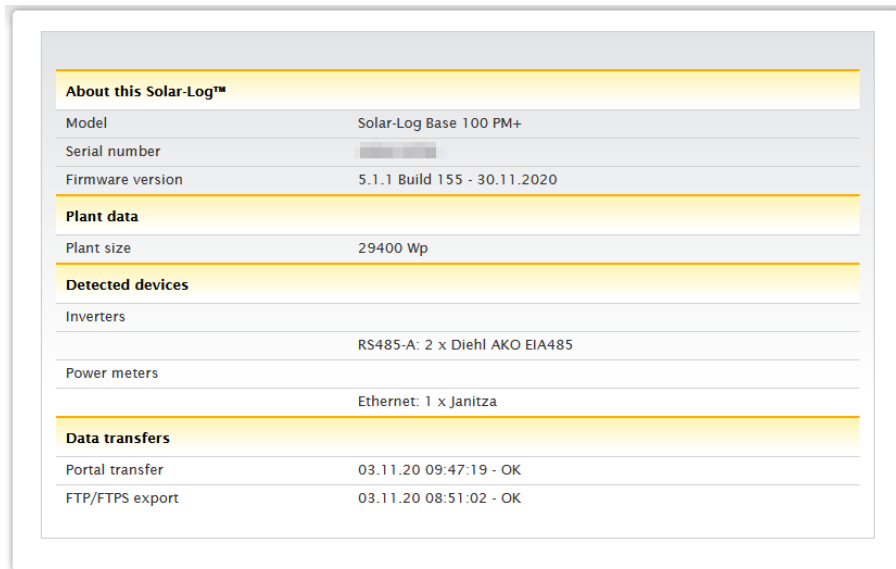

About this Solar-Log™	
Model	Solar-Log Base 100 PM+
Serial number	██████████
Firmware version	5.1.1 Build 155 - 30.11.2020
Plant data	
Plant size	29400 Wp
Detected devices	
Inverters	RS485-A: 2 x Diehl AKO EIA485
Power meters	Ethernet: 1 x Janitza
Data transfers	
Portal transfer	03.11.20 09:47:19 - OK
FTP/FTPS export	03.11.20 08:51:02 - OK

Fig.: System Info with example plant

Info Center

Information on the following sections can be accessed here:

- **Solar-Log™:**
The information about the Solar-Log™ such as the serial number, Easy Code and MAC address is located here.
- **Solar-Log WEB-Enerest™:**
Here the domain, transfer type, last transfer and ordered package can be viewed.
- **Documentation:**
This allows you to access the relevant manuals and download them if necessary or to search the component database.
- **Firmware & Support:**
Here you can access, for example, the website, support contact form and FAQs.
- **Solar-Log™ Shop:**
Here you can, for example, go to the Solar-Log™ Shop for accessories or licenses.

Important Legal Information

The legal information indications that this product uses open source components. In addition, a list of these components is displayed with the respective license texts.

Restart

This function resets the device.

14.2.5 Hide arrow

The "Hide Arrow" (on the right of the header bar) allows you to increase the amount of the page displayed in the browser by hiding the Welcome header.



Fig.: Header bar with the "Hide Arrow"

14.2.6 New Firmware

A notification is sent via the web browser when a new firmware is version available; a green triangle with an exclamation mark is displayed at the top in the status line. (See illustration: Signal for new firmware)



Fig.: Signal for new firmware

Note



The [Automatic Firmware Update Check](#) has to be activated in the [Configuration | System | Firmware](#) menu to use this function. (See illustration: Automatic Firmware Update Check with notification text displayed)

Go to the Main Menu.

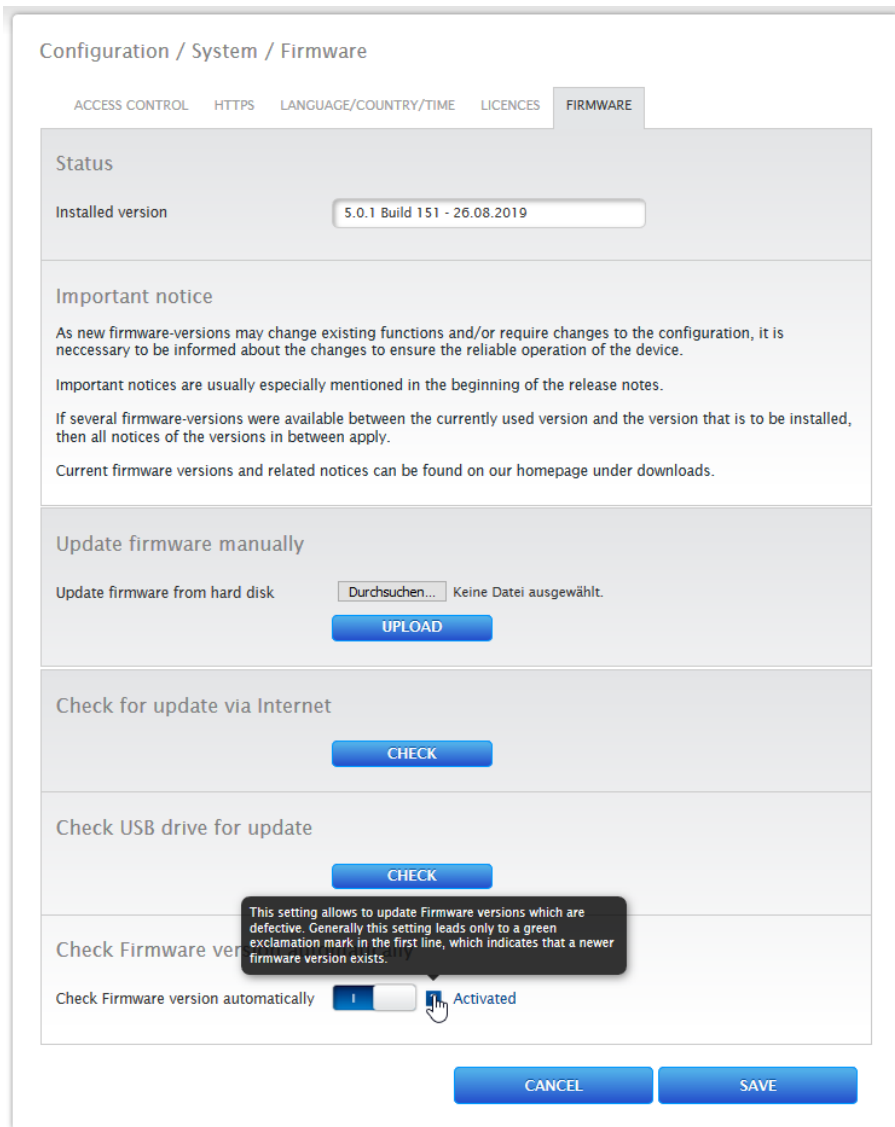

Fig.: Automatic Firmware Update Check with notification text displayed

The following notification text is displayed by clicking on the question mark:

"This settings allows firmware versions with critical errors to be automatically updated. However, generally, this setting only indicates that a new firmware version is available (green exclamation mark at the top).

When clicking on the green exclamation mark in the header bar, a window with the new firmware version will appear.

Selecting "OK" redirects you to the page of the Solar-Log Base for firmware updates. Selecting "Cancel" closes the window.

14.2.7 Installation Mode

The installation mode is used for a smooth initial installation and configuration without having import licenses right away. The installation mode is valid for 30 days and is automatically activated when using a function that requires a license. The installation mode is indicated with a blue information symbol in the top-right corner of the header. Move the mouse cursor above the symbol to see how long the mode is still valid. Click on the symbol to go to the License menu. The menu can also displays which licenses are currently active. It can also be accessed from [Configuration | System | Licenses](#)). Once the valid period has been passed, the installation mode becomes inactive. The Installation Licenses are grayed out in the Licenses menu and no longer displayed after 10 days.

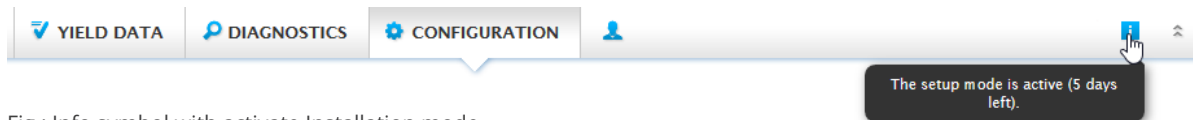

Fig.: Info symbol with activate Installation mode

Inactive Installation Mode

The installation mode becomes inactive 31 days after the initial installation and the licenses loss their validity. As a result, restrictions occur, such as no transmission of the recorded measured values via FTPS and graphics are blocked on the local web interface. The licenses can also be viewed from the Licenses menu ([Configuration | System | Licenses](#)).

Note



If a driver license needs to be purchased, this indicated with the information symbol and information text under the Interface Assignment Definition (Device Detection) when adding components.

Required Licenses

These licenses need to be purchased in order to operate without any limitations. The required licenses can be displayed, forwarded and edited in various form in the tab. The required licenses are displayed with a red triangle next to the blue information symbol in the header (see illustration).



Fig.: Red triangle with information text

Click on the red triangle to go to the Licenses menu. These menu displays the licenses that need to be purchased in order to operate without any limitations. (see illustration)

Go to the Main Menu.

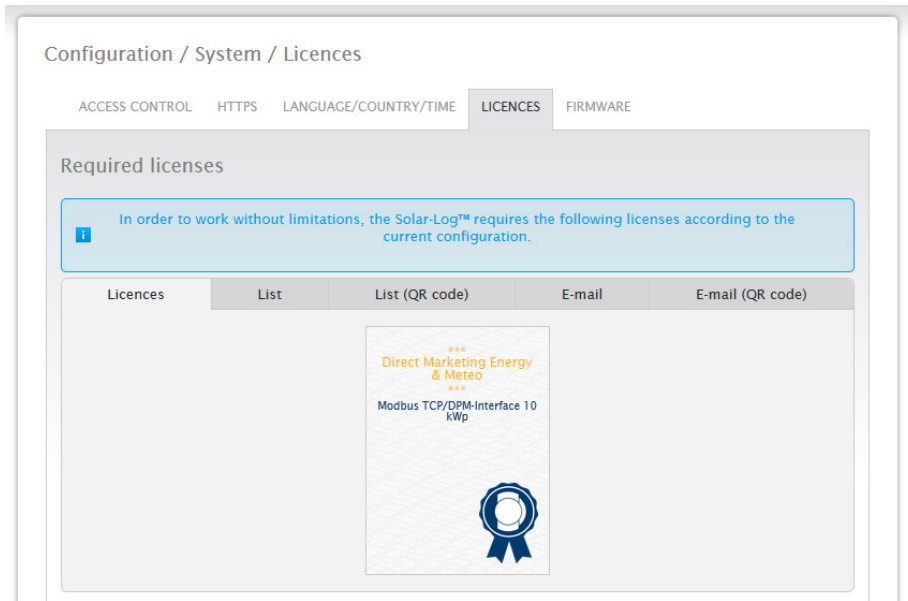

Fig.: "Licences" menu with the "Required Licenses" section (example)

The required licenses can be displayed, forwarded and edited in various form in the tab.

Licences:

The required licenses are displayed in tiled form.

List:

This function displays the required licenses in text form which can be saved in a file.

List (QR Code):

The QR code list allows the required license list to be transfer to a smartphone app.

E-Mail:

This menu allows the required licenses to be sent as a text list with the e-mail client.

E-mail (QR Code):

This menu allows the required licenses to be sent as a QR code list with the e-mail client, which can be used by a smartphone app.

Note!



A QR code scanner has to be installed on the smartphone in order to read the QR code license list.

Refer to the chapter "Licences" on how to purchase and install licenses.

14.3 Setting up of the Solar-Log™ with the configuration wizard

After the initial set up of the Solar-Log™, the Solar-Log™ starts to ask about the following settings:

- Language
- Country, Time, Set Time automatically (via NTP server)
- Browser access control

At the end, a pop-up window appears where you can start the Solar-Log™ configuration wizard. (Refer to the following image: "Startup screen of the Solar-Log™ configuration wizard").

At this point, if you do not want to continue with the setup, the configuration wizard can be stopped by clicking on the "Cancel" button. After clicking on "Cancel," the local "Cockpit" WEB page is started. The setup can be done manually from this menu. The Solar-Log™ configuration wizard can be started at anytime by clicking on Assistant under the Login Symbol. (see illustration)

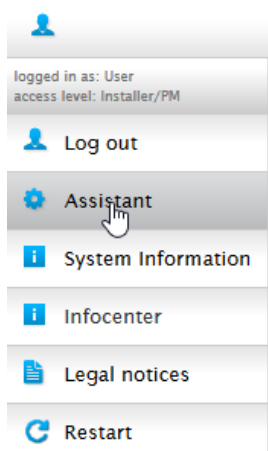

Fig.: Login symbol with selected assistant

Note



The configuration assistant can be stopped at any time by clicking on the "Cancel" button (left below the progress bar). The previously entered settings remain active.

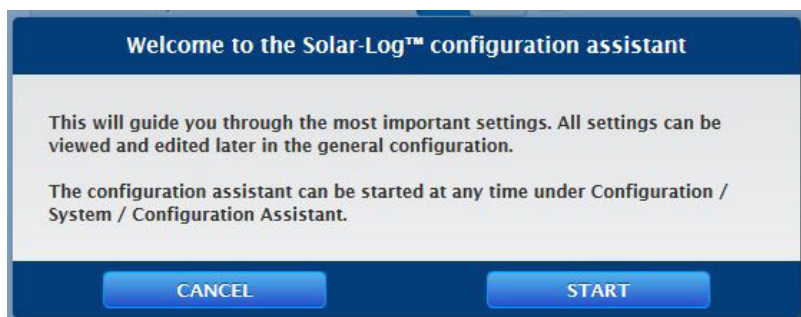

Fig.: Startup screen of the Solar-Log™ configuration wizard

Go to the Main Menu.

Click on the "Start" button to run the configuration wizard. Once started, the [Ethernet Settings](#) menu appears (see image "Solar-Log™ Ethernet Settings").

Here there is the option to activate a second Ethernet interface in order to separate the IT network from the PV plant.

Since the Solar-Log™ has DHCP (obtain IP address automatically) active by default, check whether the DHCP server has been activated on the router. If the DHCP server is disabled in the router, the network settings must be configured manually. If necessary, please consult a network specialist who can assign a suitable network address in regard to IP address, Subnet mask and Gateway, for example.

If the Solar-Log™ is to have a [fixed IP address](#), the [Obtain IP address automatically](#) (DHCP) switch needs to be [deactivated](#).

The following fields need to be adjusted according the network's configurations.

IP address

The address needs to be entered manually in order to allow remote PC access, when using a direct PC connection or a router without DHCP service.

Subnet mask

The Subnet mask is 255.255.255.0 by default and must be the same for every device in the subnet.

Gateway

The gateway is typically the IP address of the router to which Solar-Log™ is connected. That IP address is to be entered here.

Primary DNS server

In some networks, the DNS server is a separate address for resolving Internet addresses (unlike a gateway). In this case, the IP address of the DNS server is entered here.

Secondary DNS server

Enter a secondary DNS server here if it is required for the network. The secondary DNS server is used to resolve Internet address names when the primary DNS server is not available.

Once finished, click on [Save](#).

The screenshot displays the 'Configuration Assistant' window. On the left is a sidebar with a progress indicator at 0.0% and a 'CANCEL' button. Below the progress bar are menu items: 'Network', 'Device detection', 'Device configuration', and 'Portal'. The main area is titled 'Configuration Assistant' and contains two sections: 'Interface ETH 1' and 'Interface ETH 2'. 'Interface ETH 1' has a 'Deactivated' toggle for DHCP, and input fields for IP address, Subnet mask, Gateway, Primary DNS server, and Secondary DNS server, each with a help icon. A 'CONNECTION TEST' button is located below these fields. 'Interface ETH 2' has a 'Deactivated' toggle for 'Enable interface'. A 'NEXT' button is at the bottom right of the main area.

Fig.: Solar-Log™ Ethernet settings from the Solar-Log™ Configuration Wizard

Under some circumstances, it can be that a second network is required and then a second Ethernet interface can be activated. (see the following illustration)

Configuration Assistant

Interface ETH 1

Obtain IP address automatically (DHCP) Deactivated

IP address

Subnet mask

Gateway

Primary DNS server

Secondary DNS server

Internet connection

Interface ETH 2

Enable interface Activated

Obtain IP address automatically (DHCP) Deactivated

IP address

Subnet mask

Functionalities on interfaces

Device connection ETH 1 ETH 2

ModbusTCP interface ETH 1 ETH 2

i Unlisted functionalities are either only available on interface ETH 1 (e.g. internet connectivity) or on all interfaces (e.g. local web interface or public JSON interface).

The changes have not been saved.

Fig.: Example with the second Ethernet interface active

As with Ethernet 1, there are two options for IP address:

Either a dynamic IP assignment with DHCP (Obtain IP address automatically (DHCP)) or assigning a static IP address.

The following boxes need to be defined:

The IP address of the Solar-Log™, the subnet mask of the second network and the assignment of the functions for the interface. (Please pay attention to the help texts during the configuration as well as the information text below.)

Then click "save" to apply the settings.

Note



When a second Ethernet interface is required, it is important to note that the IP address of the Solar-Log™ for the second Ethernet interface needs to be "logically" separated network and cannot be the same IP address as defined for the first ethernet interface.

Explanation of the example:

If the IP address of the Solar-Log™ for the first Ethernet interface is 192.168.0.1 and the subnet mask 255.255.255.0, then the IP address for the second Ethernet interface has to be in another network (logically separated), for example 192.168.2.1 with 255.255.255.0 as the subnet mask.

Go to the Main Menu.

Connection Test

Use the "Connection Test" button to determine if the entries are correct and if a connection can be successfully established. The message indicates if the connection was successful or not. (See the following illustrations)

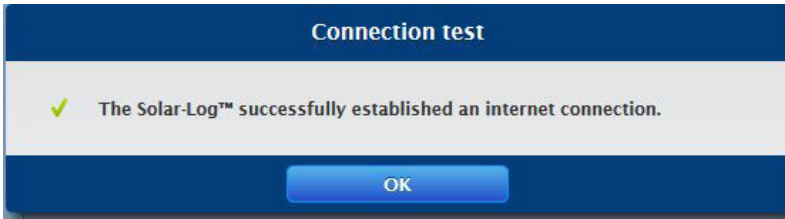

Fig.: Example of a successful connection test

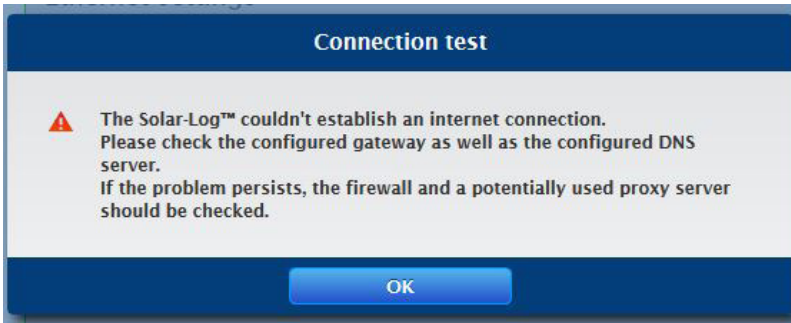

Fig.: Example of an unsuccessful connection test

Note



All entries are saved automatically by clicking on the "Next" button. Clicking on the "Back" button allows to go back and change the settings at any time.

If the test is successful, click on the "Next" button to go to the next section. A dialog window appears. From this window, you can check if a new Solar-Log™ firmware version is available (see image "Displayed Firmware Update Window").

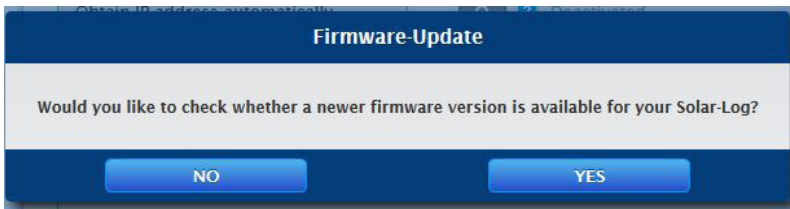

Fig.: Displayed Firmware Update Window

By clicking on "Yes," the configuration wizard checks for a new firmware version and can install it after that. At the end, the interface detection is performed. When not confirmed, the interface assignment appears.

Note



The device detection is to be performed after the components have been connected. Otherwise the corresponding boxes for the components are grayed out.

Interface assignment

The connected components have to be assigned in the interface assignment section.

Procedure:

- Click on the plus symbol.
- Select the device class, manufacturer, type (depending on device) and interface.
- Confirm by clicking on "OK."
- Repeat these steps for assigning the second interface.

When the selection of connected devices is complete, click on the "Start" to start the Device Detection. (See "Device Definition" chapter)

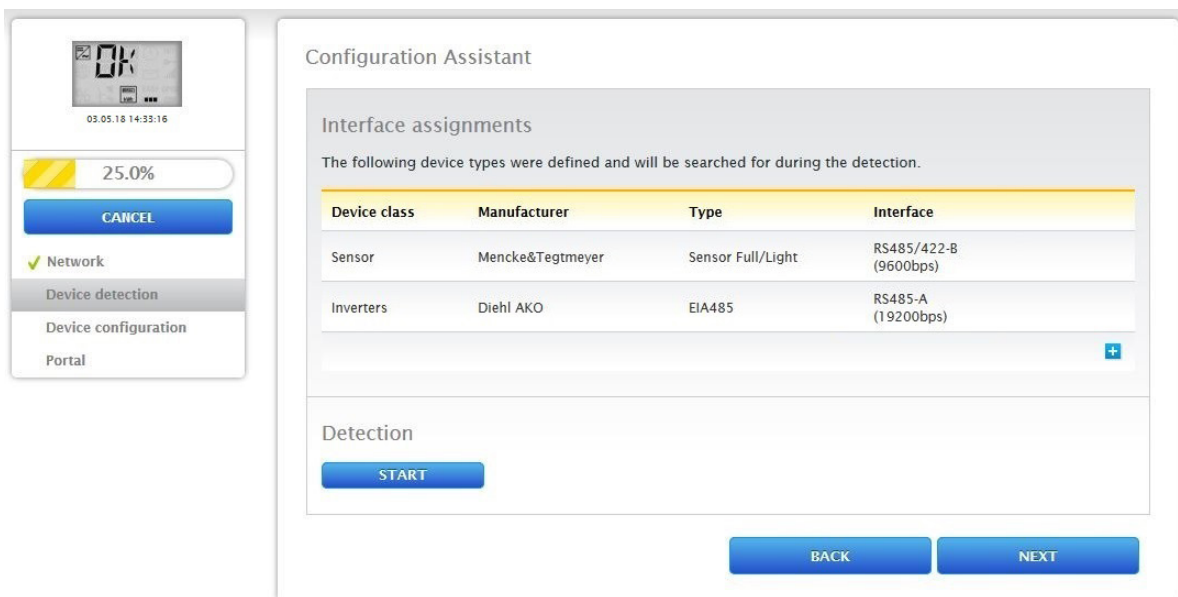

Fig.: Configuration wizard - Example - Interface Assignments

Go to the Main Menu.

Note



The device detection can be canceled by clicking on the "Skip" button – for example, when there is incorrect interface assignment or number of detected devices.

Note



The Solar-Log™ operates in installation mode for 30 days after the device detection. On day 31, "Yield Data" and "Diagnostic" no longer appear (refer to "Maximum Plant Size"). The following message appears: "Attention - import Plant Size License."

Click on "OK" after a successful detection. Then click on "Next." The device configuration menu appears. In the device configuration, one can, for example, define the generator output, the module fields and the names of the individual components. (Also refer to the chapter "Device Configuration")

Module field	Generator Power	Name
Device	14700 Wp	WR 1
MPP Tracker 1	4900 Wp	String 1
MPP Tracker 2	4900 Wp	String 2
MPP Tracker 3	4900 Wp	String 3

Fig.: Example – Configuration Wizard – Device Configuration

The "portal" page is loaded by clicking on "next." Here the data transfer to the Solar-Log WEB Enerest™ portal can be activated.

The box "Portal Server" appears once the data transfer to the Solar-Log WEB Enerest™ portal is activated. There are various options for entering the portal server:

- Option when the Solar-Log™ has already been registered on the portal:

If you know the portal server, you can manually enter it. Otherwise, there is the option to automatically enter the portal server by using the "Obtain automatically" function (above the globe symbol).

- **Option when the Solar-Log™ has not been registered on the portal:**
If the Solar-Log™ has not been registered on the portal, the function to obtain portal server automatically can be started with the globe symbol. The "portal server" box is grayed out and the Solar-Log™ goes into a waiting state and remains in this state until it has been registered in the Enerest portal. After that the Solar-Log™ obtains the portal server automatically.
- **Variant, the Solar-Log™ is connected to the WEB Enerest 4 Portal:**
If the Solar-Log™ is to be connected to the WEB Enerest 4 portal, the portal server „data.enerest.world“ must be entered.

After clicking on "Next," the configuration wizard is finished and a summary is displayed. (See illustration: "Configuration Wizard Summary")

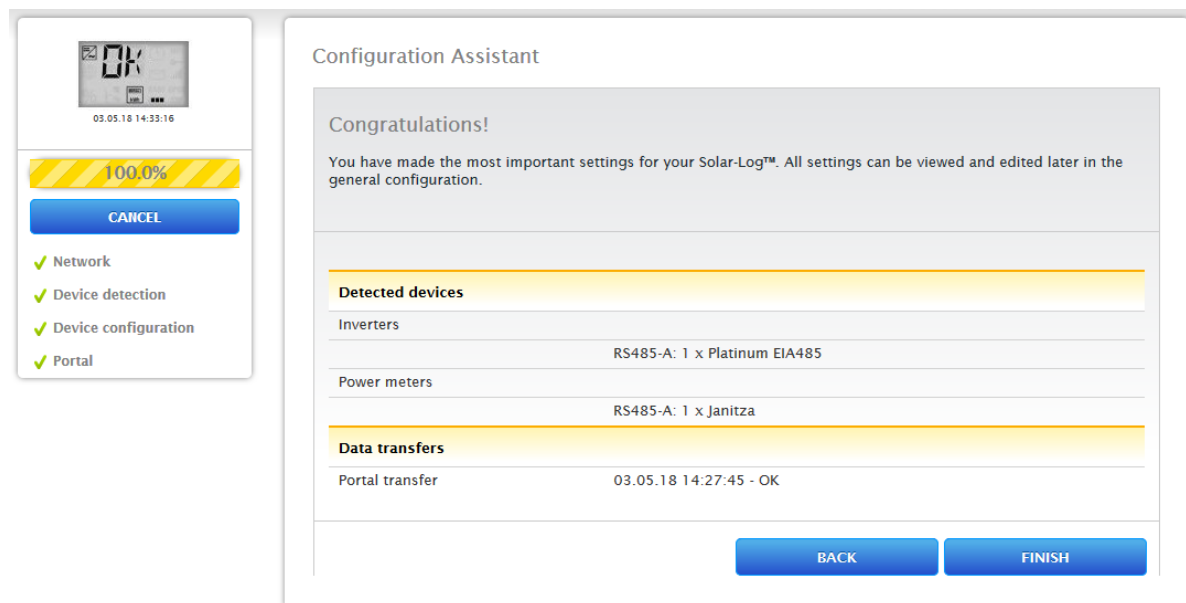

Fig.: Example – Configuration Wizard Summary

Access the menu "Yield Data" under the "Table" tab with the "End" button.

Maximum plant size

Model	Plant size	Extension licenses*
Solar-Log Base 15	15 kW	from 15 kWp to 30 kWp
Solar-Log Base 100	100 kW	from 100 kWp to 250 kWp
Solar-Log Base 2000	2000 kW	

See data sheet on our homepage ([Solar-Log Base data sheet](#)).

*See licenses in our [WEB-Shop](#)

14.3.1 Manual Configuration of the Solar-Log Base

After the device connection has been established and the Solar-Log™ has been connected to the Internet router, the basic configuration of the Solar-Log Base is done via a web browser.

All settings made at the initial startup can be changed later at any time.

Procedure:

- Enter <http://solar-log-wxyz> in the web browser address bar (wxyz stands for the last 4 digits from serial number of the Solar-Log™).
- A selection of display languages is displayed.
- Select the desired **Display Language**. Click on **Continue**.
- Define the country and time zone. **Continue**.
- The Access Protection menu is displayed. Click on **Continue** after defining the user password.
- The Configuration Wizard is displayed. Click on **Cancel** to perform a manual configuration.
- Select "**Configuration**" from the menu in the header bar.
- The following can be manually configured from the **Configuration** menu:
 - Network
 - Internet
 - Devices
 - Data
 - System

(For a detailed description of the configuration, refer to the chapter: "Configuration Menu")

15 Main menu

The main menu on the Solar-Log™ is divided into three sections:

- Configuration
- Diagnostics
- Yield data

In addition, the following sub-menus are displayed in this view:

- Cockpit
- Energy flow
- Table

These are also located on the left side of the of the VLCD Display (see "VLCD Display" section for more details) and in additional sub-menus (depending on connected the devices) and as a selection in the main navigation menu.

15.1 Virtual LCD Display (VLC Display)

The VLC Display is located above the left navigation menu and displays the notifications from the Solar-Log™ in the form of codes and symbols in addition to the date and time. The codes and symbols correspond to those for the LCD display. (See illustration "VLCD Display") The notifications are in real time.



Fig.: VLCD Display

15.2 Meaning of the symbols on the virtual LCD display (VLCD Display)

The following symbols are shown on the Solar-Log™ virtual LCD display:

Meaning of the symbols on the virtual LCD display







Symbol	Meaning
	Inverter
	Internet or Network
	Meter
	Booting progress
	Time
	Input box for fault codes
	Feed-in Management

Fig.: Virtual LCD Display - Meaning of the symbols

15.3 Fault messages

Fault messages from the connected devices

If a device cannot be contacted by the Solar-Log™ (offline), the respective symbol blinks. OK is not displayed.

Fault codes for connected devices

The respective component symbol blinks and an "E" is in the first position of the text box. A blinking code is displayed in the second position of the text box. The fault code sequence always starts with "R." That is followed by a blank and then the code numbers are displayed in the sequence.



Fig.: Example for a blinking code sequence for Internet - Fault 4

15.4 Normal operation

The symbol for the connected components is continuously illuminated. When there are no problems or faults, OK is displayed on the virtual LCD display.

15.5 Configuration

The Configuration menu is divided into the following sub-sections:

- Network
- Internet
- Devices
- Plant
- Smart Energy
- Feed-In Management
- Direct Marketing
- Data
- System

The following sub-sections of the menu will be explained separately in the following chapters.

15.5.1 Network

The network settings can be accessed from the [Configuration | Network](#) menu.

The menu is divided into the following sub-sections:

- Ethernet
- Proxy

Note



Requests and control commands are sent to the inverters, battery systems and smart consumers via the network interface. For this reason, the network should always be available (24/7).

15.5.2 Ethernet

The screenshot shows a configuration window titled "Configuration / Network / Ethernet". It has two tabs: "ETHERNET" (selected) and "PROXY".

Interface ETH 1

- Obtain IP address automatically (DHCP): Deactivated
- IP address:
- Subnet mask:
- Gateway:
- Primary DNS server:
- Secondary DNS server:
- Internet connection:

Interface ETH 2

- Enable interface: Deactivated

At the bottom of the window are two buttons: "CANCEL" and "SAVE".

Fig.: Ethernet settings for the first Ethernet interface

The network settings for the Solar-Log™ can be defined in the Ethernet menu.

There is the possibility of using two Ethernet interfaces. Both Ethernet interfaces offer partly different options of use.

The following options are available with Ethernet 1 interface:

- Local web interface & plant communication:
 - local web interface
 - Direct marketer via Modbus TCP
 - Remote control via Modbus
 - open JSON interface
- Internet:
 - Portal Solar-Log WEB Enerest™ 4
 - Firmware updates
 - FTP/FTPS transfer
 - NTP Server etc.
- Device connection:
 - Inverter
 - Meter
 - Other components (such as battery systems and smart consumers, etc.)

The following options are available with Ethernet interface 2:

- Local web interface & plant communication:
 - local web interface (the local web interface can be displayed only by using the IP address) (see Chapter 12 „Go to the main menu“)
 - Direct marketer via Modbus TCP (can be configured in parallel with selected ETH1 interface)
 - Remote control via Modbus (can be configured in parallel with selected ETH1 interface)
 - open JSON interface (can be configured in parallel with selected ETH1 interface)

- Device connection (if ETH1 interface has not been activated):
 - Inverter
 - Meter
 - Other components (such as battery systems and smart consumers, etc.)

For explanation, two example images are shown below:

Example image 1:

In this constellation with activated Ethernet 1 interface and deactivated Ethernet 2 interface, there is no separation of IT network and PV system.

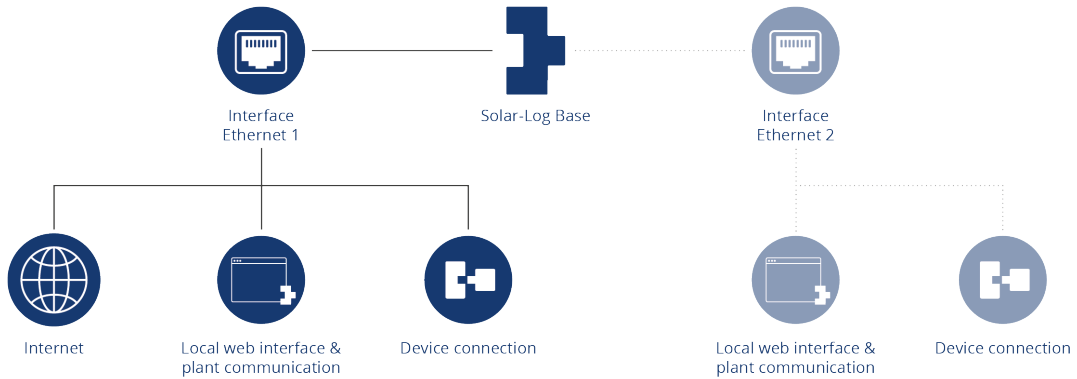

Example with activated Ethernet 1 interface and deactivated Ethernet 2 interface

Example figure 2:

In this constellation, both Ethernet interfaces are activated. Here, the IT network is separated from the PV plant because the device connection is controlled via the Ethernet 2 interface and the IT network is controlled via the Ethernet 1 interface.

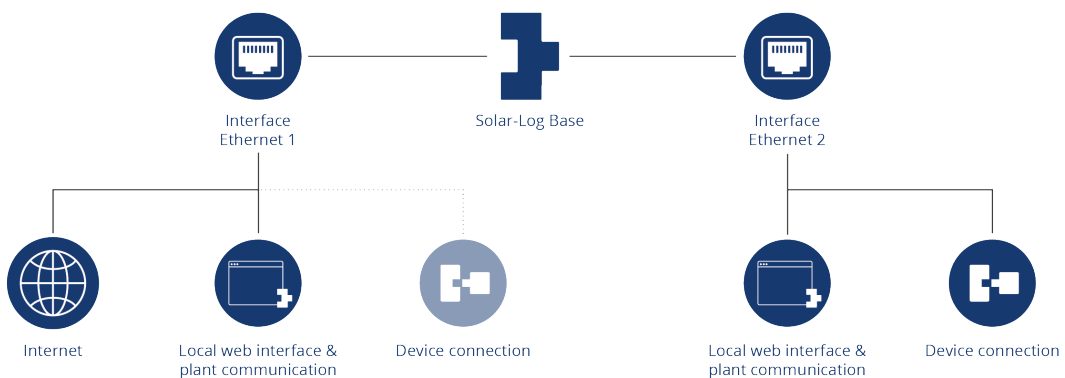

Example with activation of both Ethernet interfaces

For further descriptions of the Ethernet interfaces, see the chapter following.

15.5.3 Interface ETH 1

This chapter describes the setting options for the first Ethernet interface.

Obtain IP address automatically (DHCP)

Here the following options are available:

- Activate Obtain IP address automatically
- Deactivate Obtain IP address automatically.

Since the Solar-Log™ has DHCP (obtain IP address automatically) active by default, check whether DHCP the server activated on the router. If the DHCP server is disabled in the router, the network settings must be configured manually. If necessary, please consult a network specialist who can assign a suitable network address in regard to IP address, Subnet mask and Gateway, for example.

If the Solar-Log™ is to have a **fixed IP address**, the **Obtain IP address automatically (DHCP)** switch needs to be **deactivated**.

The following fields need to be adjusted according the network's configurations.

IP address

The address needs to be entered manually in order to allow remote PC access, when using a direct PC connection or a router without DHCP service.

Subnet mask

The subnet mask address is to set to 255.255.255.0 by default. **Gateway**

The gateway is typically the IP address of the router to which Solar-Log™ is connected. That IP address is to be entered here.

Primary DNS server

In some networks, the DNS server is a separate address for resolving Internet addresses. In this case, the IP address of the DNS server is entered here.

Secondary DNS server

Enter a secondary DNS server here if it is required for the network. The secondary DNS server is used to resolve Internet address names when the primary DNS server is not available.

Once finished, click on **Save**.

Connection Test

Use the "Connection Test" button to determine if the entries are correct and if a connection can be successfully established. The message indicates if the connection was successful or not. (See the following illustrations)

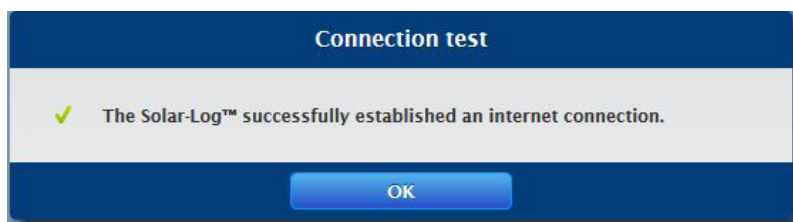

Fig.: Example of a successful connection test

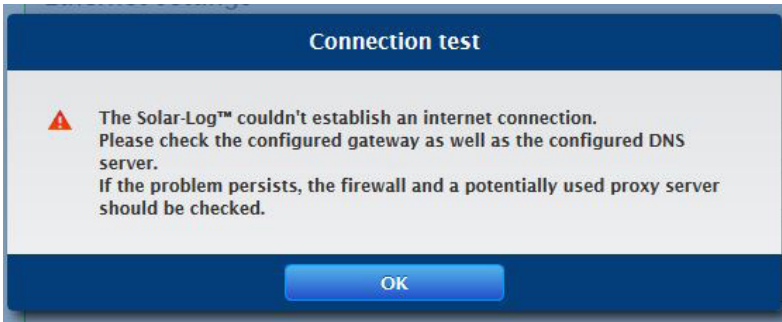

Fig.: Example of an unsuccessful connection test

15.5.4 Interface ETH 2

Here there is the option to activate a second Ethernet interface in order to separate the IT network from the PV plant.

Note



The Ethernet interface does not have any switch functions.

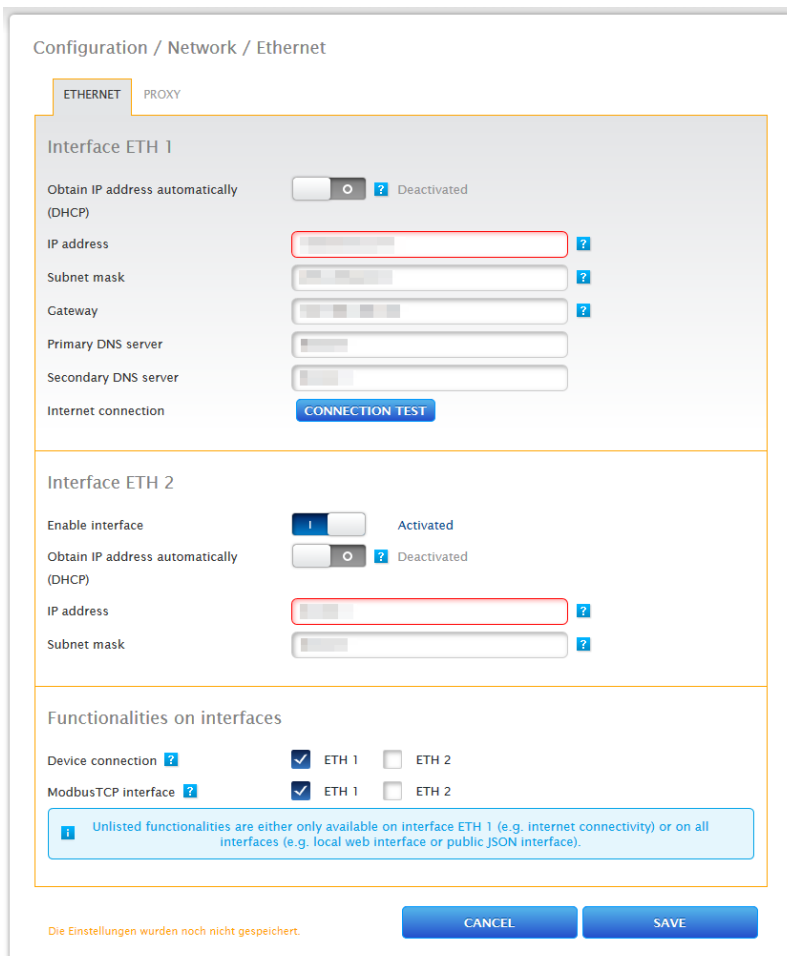

Fig.: Active second Ethernet interface

As with Ethernet 1, there are two options for IP address:

Either a dynamic IP assignment with DHCP (Obtain IP address automatically (DHCP) or assigning a static IP address.

The following boxes need to be defined:

The IP address of the Solar-Log™, the subnet mask of the second network and the assignment of the functions for the interface. (Please pay attention to the help texts during the configuration as well as the information text below.)

Then click "save" to apply the settings.

Note



When a second Ethernet interface is required, it is important to note that the IP address of the Solar-Log™ for the second Ethernet interface needs to be "logically" separated network and cannot be the same IP address as defined for the first ethernet interface.

Explanation of the example:

If the IP address of the Solar-Log™ for the first Ethernet interface is 192.168.0.1 and the subnet mask 255.255.255.0, then the IP address for the second Ethernet interface has to be in another network (logically separated), for example 192.168.2.1 with 255.255.255.0 as the subnet mask.

15.5.5 Proxy

Fig.: Proxy settings

The proxy settings need to be configured in the Solar-Log™ to enable Internet communication via the proxy server. Proxy servers are typically used in the networks of organizations and companies.

The proxy function is not enabled by default. Configure the proxy in the [Configuration | Network | Proxy](#) menu.

Procedure

- Select **Connect** for the type of the proxy server.
- Enter proxy server, port, user name and password.
- **SAVE** the settings.

15.6 Internet

Select the Internet from the [Configuration | Internet](#) menu.

The following tabs are displayed:

- Portal
- Export (only with license)

15.6.1 Portal

The following functions are available in this tab:

- Activate/deactivate transfers.
- Activated:
 - Status
 - Test

Solar-Log WEB Enerest™ section

The following selection options are available in this section:

- Activate/deactivate transfers.
- Portal server. There are two options for entering the portal server:
 - Option when the Solar-Log™ has already been registered on the portal:
If you know the portal server, you can manually enter it. Otherwise, there is the option to automatically enter the portal server by using the "Obtain automatically" function (above the globe symbol).
 - Option when the Solar-Log™ has not been registered on the portal:
If the Solar-Log™ has not been registered on the portal, the function to obtain portal server automatically can be started with the globe symbol. The "portal server" box is grayed out and the Solar-Log™ goes into a waiting state and remains in this state until it has been registered in the Enerest portal. After that the Solar-Log™ obtains the portal server automatically.
- Transfer interval.
- [SAVE](#) the settings.

Status section

The following fields are displayed in the Status section:

- [Date](#) (Last Export).
- [Error](#) (Last Export).

Test section

A connection test can be performed in the Test section. A separate pop-up window is displayed with the progress of test. The connection test also indicates if the test was successful or not. If it was not successful, it displays the error. After the tests are finished, possible causes for the connection problems are listed. (See the following example illustration).

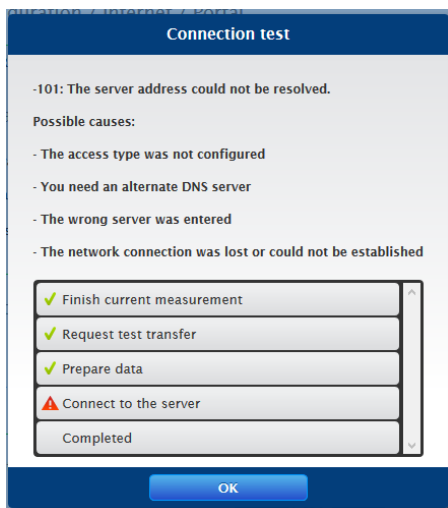

Fig.: Example - Transfer Test with an Error Image

After confirming with OK, an additional field with the status of the test is displayed in the Test section. Question marks indicate that the test was unsuccessful and possible causes are listed.

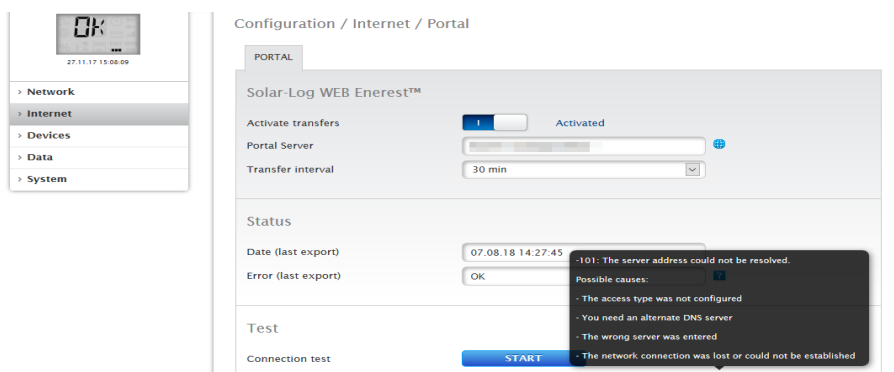

Fig.: Example - Connection Test with an Error

15.6.2 Export (only with license)

The automatic data export allows the yield data to be periodically transferred to the server. Various data formats and export intervals are available.

Note



A 30-day license is available for a new installation. If this function is required beyond that, a license must be purchased.

FTP/FTPS Export Settings section

Procedure

- **Activate** Export switch.
- **Enter** the name of the server name in the **server** box.
- **Enter** the **user name** and **password** from the server access data.
- A directory only has to be entered here if the Solar-Log™ homepage is not to be located directly in the main directory of your homepage. Otherwise, this box can be left empty.
- The **Export Interval** determines how often the Solar-Log™ transmits the data to the server.
- The following export data formats are available: CSV, Solar-Log™ or both CSV and Solar-Log™.
- The **CSV version** field can be used to define in which CSV version 0.1 or 1.0 of the Solar-Log™ should transfer the file to the server. Version 0.1 means that the CSV file is stored on the server in its previous format. Version 1.0 is a new format of the CSV file.
- The **Disable Encryption** check box can be used to configure how data is transferred to the server. If encryption is activated (the switch is set to deactivated), a certificate can be imported under SSL certificate for connection security. If the encryption is deactivated (the switch is set to activated), an transfer without encryption takes place. (See help texts)

Note



Note on FTP/FTPs:

An FTP transfer can only be used for third-party servers, as the Solar-Log WEB-Enerest™ portal for the Solar-Log Base devices only supports incremental data transfer via HTTP.

Configuration / Internet / Export

PORTAL EXPORT

FTP/FTPS Export settings

Enable export Activated

Server

User name

Password

Directory

Export interval

Data format CSV Solar-Log

CSV version

Disable encryption ▲ Activated

Status & Test

Test export

Date (last export)

Error (last export)

Status (current)

Fig.: Export with deactivated encryption (switch is set to activated)

SSL certificate

Under SSL certificate, an SSL certificate can be uploaded for a more secure connection. Please refer to the help text for more information about certificates.

Status & Test section

In this section, the export settings can be tested. The information from the last export is displayed.

- **SAVE** the settings.

15.7 Configuring connected devices

From the menu **Configuration | Devices**, the PV plant components connected to the Solar-Log™ can be

- defined
- detected
- and configured.

We recommend the following procedures for new installations:

- First define the interface to be used for the connected devices
- Device detection.
- Device configuration.

15.8 Device definition

The Configuration | Devices | Definition menu is divided into the following sub-sections:

- Interfaces
- Large External Display
- SCB (license required)

Configuring the device interface section

The interface for the connected devices needs to be defined from the Configuration | Devices | Definition | Interfaces menu before performing a device detection.

Procedure:

- Go to the plus symbol under "Interface assignments".

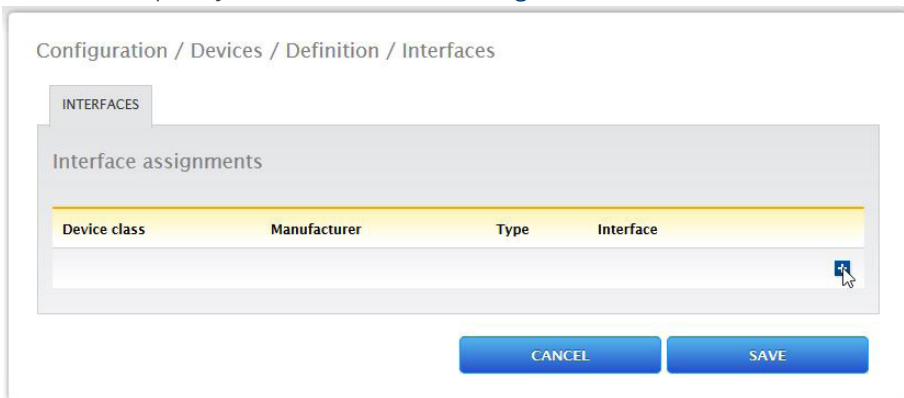

Fig.: Interface definition via the plus symbol

The following window appears:

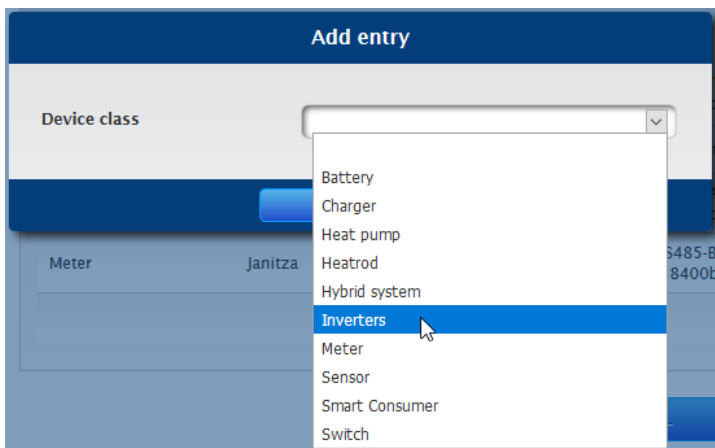

Fig.: Adding components

The connected components are selected in the Device class box. The following device classes can be defined:

- Battery
- Heating Rod
- Hybrid System
- Smart Consumers
- Charging Station
- Switch
- Sensor
- Inverter

- Heat pump
- Meter

Depending on the device class and/or the selected **Manufacturer**, additional boxes visible, as Type, Interface and Baud rate.

Furthermore, an existing **Wireless Package** can be activated here and the expected reply time for a device connected to this bus is increased.

Note



Caution: Using different manufacturers on the same serial bus may cause communication problems.



Only the network interface (Ethernet) can have multiple assignments according to our component database at <https://www.solar-log.com/en/support/component-database>.

If the device class is correct, confirm the selection with **OK**. Define additional connected device classes as described.

If all of the connected components have been selected and confirmed with **OK**, an overview is displayed in the interface assignments. (See illustration: "Overview of the selected components")

Device class	Manufacturer	Type	Interface
Battery	SMA	Sunny Island	Ethernet
Inverters	KACO		RS485-A (9600bps)
Meter	Janitza		RS485-B (38400bps)

Fig.: Overview of the selected components

From the overview, there is the option to check whether the settings are correct and, if need be, adjust or delete them with the  and  symbols. (The symbols are only displayed by moving the mouse over the components.) Additionally, the following is displayed in the overview of the device interfaces:

- Device class

The selected devices can be seen here. In the example:

 - Sensors
 - Inverter
 - Meter
- Manufacturer

The manufacturer is displayed in this column. In the example:

 - Mencke&Tegtmeier
 - Diehl AKO
 - Janitza

- Type

The defined types are listed in this column. In the example:

- Sensor Full/Light
- EIA485

- Interface

Interface indicates which interface and baud rate the devices are using.

Click on [SAVE](#) if all of the definitions are correct.

Note



The number behind the interface (e.g. x1) indicates the number of switching devices for this device type.

Note



If a driver license needs to be purchased, this indicated with the information symbol and information text under the Interface Assignment Definition (Device Detection) when adding components.

15.8.1 Device definition with the extension module - Solar-Log MOD 485

When using the expansion module - Solar-Log MOD 485, the new interfaces can be selected separately via the menu item Configuration | Devices | Definition | Interfaces.

The exact procedure for the device definition itself is described in the chapter „Device definition“.

The following point is important here: via the „Interface“ selection menu item, you can switch between the Solar-Log Base interfaces (selection via „Internal“) and the interfaces of the expansion module - Solar-Log MOD 485 (selection via „Mod 485“). (See the following figures).

The screenshot shows the 'Add entry' dialog box. The 'Device class' is set to 'Inverters', 'Manufacturer' to 'Kostal', and 'Type' to 'Piko MP'. The 'Interface' dropdown menu is open, showing 'Internal' (selected) and 'Mod 485'. The 'Wireless package' is set to 'Deactivated'. There are 'CANCEL' and 'OK' buttons at the bottom.

Fig.: Example - Interface selection between Solar-Log Base (Internal) and MOD 485 (Mod 485)

The screenshot shows the 'Add entry' dialog box. The 'Device class' is 'Inverters', 'Manufacturer' is 'Kostal', and 'Type' is 'Piko MP'. The 'Interface' dropdown menu is open, showing 'Mod 485' (selected) and a list of options: 'RS485-A', 'RS485-A', 'RS485-B', 'RS485-C', and 'RS485-D'. The 'Wireless package' is 'Deactivated'. There are 'CANCEL' and 'OK' buttons at the bottom.

Fig.: Example - Interface selection MOD 485 and RS485

The screenshot shows the 'Add entry' dialog box. The 'Device class' is 'Inverters', 'Manufacturer' is 'Fronius', and 'Type' is 'SolarNet'. The 'Interface' dropdown menu is open, showing 'Mod 485' (selected) and a list of options: 'RS422-AB', 'RS422-AB', and 'RS422-CD'. The 'Wireless package' is 'Deactivated'. There are 'CANCEL' and 'OK' buttons at the bottom.

Fig.: Example - Interface selection MOD 485 and RS422

Note

Simultaneous use of RS485 and RS422 on the same interface is not possible.

15.8.2 Device Detection

During the Device Detection, all of the components that have been predefined in the Configuration | Devices | Definition are searched for and detected. The internal data structure of the Solar-Log™ is prepared for the detected components.

Procedure:

- Select Configuration | Devices | Detection from the menu.
- The components which were predefined in the Device Definition menu are displayed in the overview.

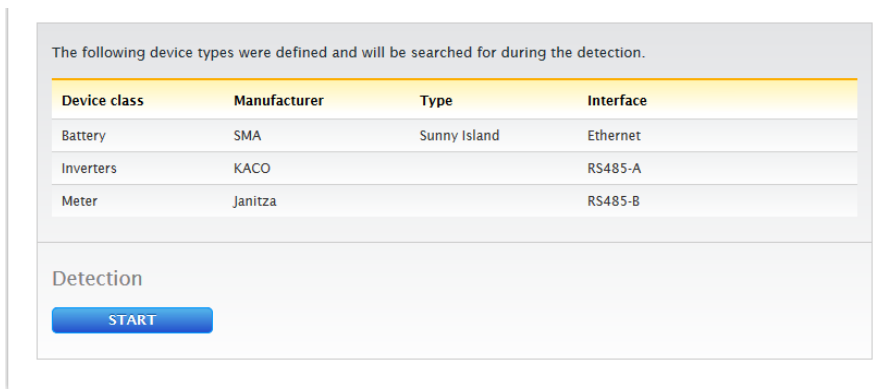



Fig.: Device detection - not started yet

- **START** Device Detection.
- The Device Detection goes from the top listed interface to the bottom listed interface when searching for devices.

The progress of the device detection is displayed in a window that automatically appears.

- The detected devices are displayed with the number of devices per bus.
- If all of the devices on a bus have been detected, the rest of the search can be skipped. The search is then continued on the next bus.
- The Device Detection is completed once all of the buses have been checked.
Status message: New device detected, the data is being reformatted.
- The Solar-Log™ reboots itself.

Note

Once the detection has been successfully completed, individual device classes can be removed with the  symbol without having to initialize the complete device configuration.

15.8.3 Configuring devices

After the Device Detection has been successfully completed, the detected devices have to be defined in the [Configuration | Devices | Configuration](#) menu.

Depending on the device, different settings might be needed for the configuration.

Procedure:

- Select the device that needs to be configured in the Device Configuration section.
- Depending on the device type, different configuration boxes appear.
- The entries for the sections below – “Module Fields, Power Output and Descriptions” – are mostly identical.

Configuring inverters

The following values have to be configured for inverters:

- Maximum AC Power.
- Pac Correction Factor.
- Module field.
- Generator Power and MPP tracker output (according to the string plan)
- Labels or names of the inverters and/or MPP trackers.

Procedure:

- [Select Device](#).
- Enter the
- [Maximum AC power](#):
from the inverter's data specification in the section: Module Field, Power and Name.
- Enter the [Pac Correction Factor](#) (for more information, refer to the section [Generation Information on PAC Correction Factor](#)).
- Define [Module Field](#):
Inverters can be assigned to be different module fields. See Chapter: „15.8.11 Module Fields, Power Output and Descriptions“.
- [Generator Power](#):
The connected power of the individual inverters in Wp. The total power can be calculated using the formula: Module power * Number of modules. The output does not have to be entered. It is calculated from the total generator power values that have been entered for the MPP Tracker.
- The [generator power](#) for every [tracker](#) needs to be entered if the inverter has several MPP trackers.
- A distinct name can be assigned to every generator/MPP tracker in the [Label](#) box.
- [SAVE](#) the settings.

15.8.4 Generation Information on PAC Correction Factor

At photovoltaic plants, several measuring points and power generators (inverters) are combined with one another. The Solar-Log™ evaluates this data and partially looks for any correlations.

For example, if the total amount of energy produced based on what the inverters display is compared with the values from calibrated power meters, deviations of up to 8 % can arise.

In practice, meters and inverters both can display too much or too little kWh.

To correct these inaccuracies in the medium term, the Solar-Log™ firmware uses a PAC correction factor.

Calculating the PAC correction factor

All yield data are always stored internally without any correction factor. This factor is applied only when the data are displayed. The factor can therefore be adjusted at any time.

The formula for calculating the correction factor is as follows:

$(\text{Yield power meter} / \text{yield inverter}) * 1000$

If the inverter does not have a display, it is advisable to use the values which are recorded by the Solar-Log™ from a period over a week.

That is why it is recommended to leave the default PAC correction factor at 1000 initially.

The correction factor can be adjusted yearly after receiving the statement from the utility company.

Example calculation:

Inverter 1	Inverter 2	Calibrated power meter
Total energy	Total energy	Total energy
259.12 kWh	305.22 kWh	550.55 kWh
Total = 564.34 kWh		Deviation= 13.79 kWh

By comparing the values, you see that the inverters are more likely to display too much output.

Pac Correction Factor

Calibrated power meter total energy	Inverter total energy
550.5 kWh	564.34 kWh
Calculated PAC correction factor in the example.	
$(550.55 \text{ kWh} / 564.34 \text{ kWh}) * 1000 = 975.66$	
Rounded PAC correction factor = 976	

15.8.5 Configuring power meters

An operating mode needs to be assigned to power meters to configure them.

Possible operating modes for power meters:

- Generator (records the individual producers, e.g. PV inverter or CHP).
- Meter for the entire plant (records the complete PV plant output).
- Consumption meter (records the complete consumption).
- Utility Meter (U).
- Utility Meter (U+I).
- Utility Meter (U+I) + Consumption Meter (bi-directional).
- Sub-consumption meter (records the consumption from individual appliances).
- Consumption Meter (Bi-directional meter).
- Battery meter (Bi-directional meter).
- Deactivated.

Depending on the selected operating mode and/or meter type, additional selection boxes appear, such as **Energy type** and/or **Impulse rate**.

Note



Several consumption meters can be defined for every plant. Their measurements are added to the total consumption.

Note



A sub-consumption meter is a consumption meter whose consumption has already been recorded by another meter. It is used to visualize the consumption from a particular appliance or group.

Procedure

- Select Device.
- Select the desired operating mode from the Meter configuration section.
- If needed, assign a plant group to this meter.
- SAVE the settings.

15.8.6 Configuring sensors

Under sensors, the configuration only comprises of activating other sensors.

Procedure:

- Use the **Ambient Temperature** and/or **Wind** button to activate the sensors.
- If needed, make assignments to the module field.
- **SAVE** the settings.

15.8.7 Configure the battery

The following configurations can be made here for the connected battery.

- **Battery size:**
Enter the battery size in Wh in this box.
- **The consumption meter records the battery charge:**
This box enables recording the battery charges from the consumption meter.
- **Delay battery charge:**
With this function, charging the battery can be delayed based on the weather forecast so that the battery is charged an expected power reduction occurs to prevent energy from being wasted.

Note



The following components always have to be used for battery monitoring to work:

- ▶ Inverter
- ▶ Battery
- ▶ Consumption meter

Note



Refer to the chapter "Battery Diagnostic" for further details on diagnostic.

Battery charging time shift function (only with Varta battery energy storage system):

When the plant has to fulfill a percentage based reduction (x% - EEG/subvention), the Solar-Log™ can shift the charging time of the battery to a period of peak power production, thus eliminating the need to reduce the total output. The Solar-Log™ includes the weather forecast data and plant consumption data into the calculation for battery charging management. This means that Solar-Log™ saves the typical consumption data from the past and checks this data to ensure that the battery is charged completely. The charging times are adjusted accordingly as needed.

15.8.8 Configuring AC-ELWA-E

The AC-ELWA-E can be selected and configured accordingly from the Device Configuration section in the [Configuration | Device | Configuration](#) menu.

For configuration and settings please refer to the Smart-Energy manual downloadable from our homepage:

[Smart-Energy manual](#)

15.8.9 Configuring IDM Heat Pumps

The IDM heat pump can be selected and configured accordingly from the Device Configuration section in the [Configuration | Device | Configuration](#) menu.

For configuration and settings please refer to the Smart-Energy manual downloadable from our homepage: [Smart-Energy manual](#)

15.8.10 Configuring the Keba Power Charging Stations

The Keba power charging station can be selected and configured accordingly from the Device Configuration section in the Configuration | Device | Configuration menu.

For configuration and settings please refer to the Smart-Energy manual downloadable from our homepage:

[Smart-Energy manual](#)

15.8.11 Module Fields, Power Output and Descriptions

Depending on the device type (power meter, inverter, etc.), different settings can be adjusted from the **Module Fields, Power Output and Descriptions** menu. See the following chapters:

- Configuring inverters,
- Configuring power meters and
- Configuring sensors.

In this section, for example, the device name can be changed and the nominal power (maximum AC output) of the individual devices can be defined.

The nominal power (maximum AC output) is the average consumption or the average energy production of a device and is used, for example, for the profile controls (Smart Energy).

Note



The most exact that the configured nominal power corresponds to the actual consumption, the more accurately the control of consumption via Smart Energy is.

Module Fields

Each connected MPP tracker is assigned to a module field. Module fields are subdivided according to the type of the solar module, angles of inclination and alignment. If all modules within a system are of the same type and have the same alignment, only one module field, e.g. "1", is defined. MPP trackers that are not used must be switched off (switched to "0").

Additional module fields need to be defined for modules with different alignments and module types.

Ideally, each field should be made up of at least two individual MPP trackers, which monitor each other. The module fields are used for performance monitoring. In contrast, plant groups (Chapter "Plant groups") are used for the commercial calculations.

Example module fields:

A plant with 23.6 kWp is divided into:

3 x SMA SB5000TL and

2 x SMA SB2500.

18 kWp is located on a barn roof with 30° inclination, 20° South-East deviation, and 5 kWp on an adjoining garage roof, 32° inclination, 0° South deviation.

This results in two module fields according to the following table:

Division of the module fields

Location	Inverter	MPP Tracker output	Module field
Barn	1. SB5000TL	2000	1
Barn	1. SB5000TL	2000	1
Barn	1. SB5000TL	2200	1
Barn	2. SB5000TL	2000	1
Barn	2. SB5000TL	2000	1
Barn	2. SB5000TL	2200	1
Barn	3. SB5000TL	2000	1
Barn	3. SB5000TL	2000	1
Barn	3. SB5000TL	2200	1
Garage	1. SB2500	2500	2
Garage	2. SB2500	2500	2

Changing the device order section

The sequential order of the inverters and other devices is determined during inverter detection. They are normally sorted by their serial number or communications address.

The order can be changed through drag and drop from the [Configuration | Devices | Configuration | Order](#) menu.

15.9 Configuring Plant Data

There are settings for the following sections in the **Plant** menu:

- General
- Plant groups
- Graphic
- Forecast

15.9.1 General

Environmental performance

The CO2 factor per kWh can be setup for each electricity tariff. The value is displayed in g/kWh. Contact your power company for the exact number for this value. The default setting for this value is 700g/kWh.

15.9.2 Plant groups

Since the Solar-Log Base can manage up to 100 inverters at the same time, it is helpful to divide these inverters into groups. To provide a clearer overview, these groups are then shown in all selection dialog boxes. The data from each plant group can be presented on its own large external display. Each plant group can also be combined with its own consumption meter.

An individual name can be assigned to each asset group, Plant groups are therefore also suitable for managing system expansions.

Example: If a plant initially has 5 inverters and 30 kWp and is extended at a later date with 3 more inverters and 20 kWp, this addition can be conveniently managed as a separate group with one Solar-Log™.

Individual inverters can then be selected from the group concerned. Plant groups are defined starting with 15 inverters. A maximum of 10 plant groups can be defined.

Note



When using several plant groups, only one plant group can be used with a tariff mode with self-consumption refund or self-consumption.

Note



The function "Distribute automatically" sorts only unassigned devices into groups.

Procedure:

- Select [Configuration | Plant | Plant groups](#) from the menu.
- To use [Plant buttons](#), the button needs to be activated.
- Under [Name](#), a plant group can be uniquely [labeled](#).
- The devices recognized during the Device Detection are now allocated into the device groups.
- Click on  to display a list of all of the devices.
- Place a [check](#) in the box next to the devices that belong to this plant group and select [Apply](#).
- For the next steps, additional plant groups and their devices can be defined in the same way.
- [SAVE](#) the settings.

15.9.3 Graphic

The scale of the graphic for individual devices can be adjusted in the graphic menu. Nothing usually has to be changed here, as Solar-Log™ automatically calculates the values for the generator power input. The values can be adapted to your own data.

For each period (day, month, year, total) the maximum value represented in kW can be entered (except Day, which is a value in W).

The graph shows these values on the Y-axis.

Changes become effective when a new graph is displayed or after updating a displayed graph.

The "[Recalculate](#)" function resets the values in the Solar-Log™ and automatically recalculates a new graphic scaling (based on an average plant).

This function can be activated continuously with the switch [Graphic Auto scaling](#) (deactivated by default). The auto scaling option always scales the graphics up as much as possible in the [yield data](#) section. Auto scaling can be disabled for individual graphics.

This function can be activated permanently with the switch [Consumption Line Graphic](#) (deactivated by default). The consumption line graphic can be disabled for individual graphics.

15.9.4 Defining the PV plant's forecast data

By setting forecast values for the yield data, you can check on the graph whether the plant is reaching the desired annual yield or not.

To do this, a percentage rate is allocated to each month. This is deduced from the yield statistics over the previous years.

Solar-Log™ always calculates the target value cumulatively, per day. This means that, at the beginning of the month, it is not the total monthly target that is set, but the target for days already passed, plus that of the current day.

In the forecast, Solar-Log™ also takes account of the yields in all previous years, and in this way can allow for local weather events (in most cases, snow in December). The yearly forecast is therefore usually fairly accurate by September.

Yearly target section

Enter the yearly target value from the installer's plant project planning. The unit of this value is kWh/kWp. Fundamentally, this value depends on the overall irradiation at the plant's location and local factors such as the plant's alignment and shadowing.

In Central Europe, this value is roughly in the range from 800 to 1000 kWh/kWp.

If plant groups are used, it is possible to define a [separate yearly target for each for each plant group](#).

Monthly shares & course of sun section

In this section, the settings for the following can be configured for each month:

- Percentage of the yearly target,
- Sunrise and
- Sunset.

Please note that the sum of all of the monthly percentages of the yearly has to always add up to 100%.

16 Smart Energy

For the Smart-Energy settings and their operation, see the Smart-Energy manual on downloadable from our homepage:

[Smart-Energy manual](#)

17 Feed-In Management

For the settings of the feed-in management, their modes of operation as well as their implementation in connection with the specifications of the grid operators and also in particular the VDE 4110 see the Manual - Feed-In Management Control downloadable from our homepage:

[Manual - Feed-In Management Control](#)

18 Direct Marketing

To activate Direct Marketing, go to the menu **Configuration | Direct Marketing** and set the remote control option to **Modbus**. After that, a direct marketing package (.bdl) can be loaded under "Integrated OpenVPN Tunnel). For this option, the proper direct marketing package for the plant has to be ordered from Solare Datensysteme GmbH. Once the package has been ordered and is ready to be downloaded, it can be imported via "Upload File." After the file has been imported, the VPN tunnel connection is established and the connection to the direct marketer is started.

Click on the "Stop" button to cancel the direct marketer connection. The package can be removed by clicking on "De-install." There is also the option to download the log file by clicking on the "Download" button in the Log section. This file logs the connection to the direct marketer via the VPN tunnel. (Refer to the figure below.)

Note



When the "Remote control option: Modbus" is activated, a 30-day installation license is created. If the function is used after the 30-day, the license needs to be purchased. (Refer to the chapter "Licenses")

Configuration / Direct Marketing

Setup mode

This function is part of the setup mode.

The setup mode is still active for: 22 days.

After expiration, this function will be deactivated automatically!
For use, you need a paid license.

[Switch to the overview of the required licenses](#)

Remote Control options

Modbus ▼

Integrated OpenVPN tunnel

STOP
UNINSTALL

Status	Active
IP address	<input type="text" value=""/>
Subnet mask	<input type="text" value=""/>
Protocol	DOWNLOAD

CANCEL
SAVE

Fig.: Direct marketing with imported example package

19 Data

The Configuration | Data menu offers several functions in regard to the data recorded by the Solar-Log™ and contains the following options:

- Initial yield
- Data correction
- System backup
- Backup
- Reset

19.1 Initial yield

This function manually imports initial yields from previous recorded daily data into the Solar-Log. This is useful any time that a large amount of data has to be changed and would take too long with the "Data correction" function. The Data import deletes the existing data memory completely before the daily data is imported from a CSV file. Therefore, the data import should be carried out immediately after the startup of Solar-Log™. The Initial yield can contain production, consumption or self-consumption values.

Note



A data import can only be made if all inverters have been correctly detected and configured or if a valid system configuration has been imported.

The data has to be in the CSV format for the import. Files in the CSV format can be created with simple text editors or spreadsheet programs like MS Excel or Open Office Calc.

The import file must consist of individual rows of text, in which the date and daily yield value in "Wh" (not kWh!) are separated by semicolons (CSV format).

Example:

DD.MM.YY; Production in Wh; Consumption in Wh; Self-consumption in Wh

27.04.20;136435;264371;33684

28.04.20;138219;213145;43476

etc.

Note: Here, the year value should also consist of 4 digits.

Procedure:

- Click on **Browse**.
- The file manager of your OS appears.
- **Select the CSV file** that is to be imported
- The selected file name is displayed
- Click on **Upload**.
- The progress and status of the data import are displayed.
 - Upload file
 - End current measuring
 - Delete all of the old data and initialize structure

Import daily data
 Calculate monthly/yearly data
 restart

- The Solar-Log™ resets itself.
- Check the imported data in the yield data section.

19.2 Data correction

Here you can adjust the values for previous days or change daily totals.

Procedure

- Enter a 6-digit date
 DD/MM/YY
 For example: 25.04.20 for 25 April 2020.

The following values can be corrected:

- Daily yield (kWh)
- Daily consumption (kWh)
- Daily self-consumption (kWh)
- Daily self-consumption Battery (kWh)

If consumption or yield values were modified with the data correction option, these corrected values are displayed additionally in the key and in the yield data under the Production | Day and Balances | Day menus.

19.3 System backup

The Configuration | Data | Backup menu offers the following functions:

- Restore configuration from hard disk.
- Save configuration to hard disk.
- Save configuration to USB.
- Restore configuration from USB.

The system data consist of all the data that have been saved in the configuration. It is recommended always to make a backup of the system data before changing the configuration or updating the firmware.

Restoring configuration from hard disk section

This function imports the configuration file from the solarlog_config.dat file into the Solar-Log™.

Procedure:

- Click on **Browse**.
- The file manager of your OS appears.
- **Select the DAT file** that is to be imported.
- The selected firmware's file name is displayed.
- Click on **Upload**.
- The configuration is being imported. Please wait a moment.
- The Solar-Log™ reboots itself.

Saving configuration to hard disk section

With the function a configuration file can be created and saved to a hard drive. A Solar-Log configuration file has the following file name: "solarlog_config.dat."

Procedure:

- Click on **Prepare**.
- After the data has been prepared, the Download option is displayed.
- Click on **Download**.
- Depending on your browser settings, a window pops up with the options to open the file with a program or save file.
- Select **Save file**.
- The file is saved in the download folder.

Alternative procedure:

- Click on **Prepare**.
- After the data has been prepared, the Download option is displayed.
- Right click with the mouse on **Download**.
- Select **Save link as**.
- The file manager of your OS appears.
- Select the desired location to save the file to.
- Select **save**.
- The file is saved in the selected folder.

Saving configuration to USB section

With this function, a backup can be saved to a USB stick which is directly connected to the device.

Procedure:

- Touch **Save**.
- The configuration is being created. Please wait a moment.
- The progress and status of the update are displayed.
Finish current measurement.
Select the USB storage device
Save configuration.
- The solarlog_config_YYMMDD.dat file is saved in the /Backup directory of the USB stick.
YYMMDD stands for year, month and day - each two digits, e.g. solarlog_config_200425.dat is then the backup from 25 April 2020.
- The configuration file can be saved elsewhere as a backup or imported into the Solar-Log™ again.

Restoring configuration from USB section

This function imports the solarlog_config.dat (or solarlog_config_YYMMDD.dat) configuration file from a USB stick which is directly connected to the device into the Solar-Log™.

Procedure

- Click on **Restore**.
- A search for a back-up file is carried out on the USB stick.
If not already present, this configuration file (solarlog_config_YYMMDD.dat) must have been stored in a / backup directory beforehand. (Please create a /backup directory beforehand if one is not already present). A search for the configuration file is carried out in this directory.
- Start this search.
- When a configuration file is found on the USB stick, click on **RESTORE** to import it.
This data is being imported.
Please wait.
- The Solar-Log™ reboots itself.
- The configuration file was imported.

19.4 Backup

The Configuration | Data | Backup menu offers the following functions:

- Restore data backup from hard drive.
- Save data backup to hard drive.
- Save data backup to USB
- Restore data backup from USB

Restore data backup from hard drive section

This function restores the backup file with the name solarlog_backup.dat to the Solar-Log™.

Procedure:

- Click on **Upload**.
- The file manager of your OS appears.
- **Select the DAT file** that is to be imported.
- The selected backup's file name is displayed.
- Click on **Upload**.
The configuration is being imported. Please wait a moment.
- The Solar-Log™ reboots itself.

Saving data backup to hard drive section

With the function a backup can be created and saved to a hard disk.

A Solar-Log backup file has the following file name: "solarlog_backup.dat."

Procedure:

- Click on **Prepare**.
- After the data has been prepared, the Download option is displayed.
- Click on **Download**.
- Depending on your browser settings, a window pops up with the options to open the file with a program or save file.
- Select **Save file**.
- The file is saved in the download folder.

Alternative procedure:

- Click on **Prepare**.
- After the data has been prepared, the Download option is displayed.
- Right click with the mouse on **Download**.
- Select **Save link as**.
- The file manager of your OS appears.
- Select the desired location to save the file to.
- **Select save**.
- The file is saved in the selected folder.

Saving data backup to USB section

With this function, a backup can be saved /Backup directory of a USB stick which is directly connected to the device.

Procedure:

- Touch **Save**.
- The backup is being created. Please wait a moment.
- The progress and status of the update are displayed.
Finish current measurement
Select the USB storage device
Save configuration
- The solarlog_backup_YYMMDD.dat file is saved in the /Backup directory of the USB stick.
YYMMDD stands for year, month and day - each two digits, e.g. solarlog_backup_200425.dat is then the back-up from 25 April 2020.

The Solar-Log™ backup can be copied to another storage medium or imported into the Solar-Log™ again.

Restoring backup from USB section

This function restores a backup file with the name solarlog_backup.dat from the USB stick connected directly to the device to the Solar-Log Base.

Procedure:

- Click on **Restore**.
- A search for a back-up file is carried out on the USB stick.
If not already present, this back-up file (solarlog_backup_YYMMDD.dat) must have been stored in a /backup directory beforehand. (Please create a /backup directory beforehand if one is not already present). A search for the back-up file is carried out in this directory.
- **Start** this search.
- When a configuration file is found on the USB stick, click on **Restore** to import it.
- The backup is being restored. Please wait a moment.
- The Solar-Log™ reboots itself.
- The configuration file was imported.

19.5 Reset

The Configuration | Data | Reset menu offers the following functions:

- Reset the yield data.
- Reset the inverter configuration.
- Restore factory settings.

Resetting yield data section

In certain circumstances after an inverter detection, it may occur that incorrect or unusable data is displayed. In this case, the stored data can be deleted without having to reconfigure the Solar-Log™ completely.

Procedure:

- Click on **RESET**.
- If you are sure that the data should be deleted, click on Continue. Otherwise click on Cancel.
- The data is being deleted.
- The Solar-Log™ reboots itself.

Resetting inverter configuration section

If the Device Detection needs to be started again, it is recommended to delete the previous inverter configuration with this function.

Procedure:

- Click on **RESET**.
- If you are sure that the inverter configuration should be deleted, click on Continue. Otherwise click on **Cancel**.
- The data and inverter configuration are deleted.
- The Solar-Log™ reboots itself.

Restore factory settings section

This function restores the Solar-Log™ to its factory settings. All of the yield data and configuration is deleted.

Procedure:

- Click on **RESET**.
- If you are sure that the data should be deleted, click on Continue. Otherwise click on **Cancel**.
- The factory settings are being restored.
- The Solar-Log™ reboots itself.

Note



The network settings remain when this function is used.

20 System Configuration

The Configuration | System menu has the basic settings for the Solar-Log™ and contains the following tabs:

- Access control
- HTTPS
- Language/Country/Time
- Licenses
- Firmware

20.1 Access control

Browser access protection for the Solar-Log™ can be configured in this menu. The following parts of the Solar-Log™'s browser menu can be restricted with a password:

- User:
General access to the [browser menu](#).
- Installer:
Access to the [Configuration](#) menu.
- Feed-in management:
Access to the [Configuration | Feed-in Management](#) menu.

The default password for access to the Feed-in Management menu is PM. Access for users and installers is not restricted.

Note



We advise installers to discuss with their customers the scope of the settings in the area of feed-in management, to block the configuration menu using a password and to assign an individual password.

Procedure:

- Activate the password restriction for the desired menus.
- Enter a secure password for each of the menus.
- Enter the password again.
- SAVE the settings.

20.2 HTTPS

The following sections are located here:

- SSL certificate
- User-specific certificate

SSL certificate

An SSL certificate is a code on the web server that secures online communication. When a web browser connects to a website, the SSL certificate provides a secure connection.

The Solar-Log™ uses such an SSL certificate. This can be imported into the web browser or the operating system. There is also the option to use your own SSL certificate instead of the Solar-Log™ certificate.

There are four different boxes under SSL certificate:

- Status:
This indicates which certificate the Solar-Log™ is currently using.
- SSL certificate fingerprint:
The correctness and authenticity of the certificate used can be verified by means of the fingerprint. This is done by comparing the string displayed in the field with the reference sequence in the browser.
- Issue a new certificate:
You can use the button issue a new certificate, but the certificate currently used will be irrevocably deleted.
- Download SSL certificate:
The Download button offers the option to download the SSL certificate and to import it into the browser or operating system.

User-specific certificate

An user-specific certificate can be uploaded in this section. Go to "Browse" to select the certificate you want to upload.

Note



Please note the help texts in the individual sections.

20.3 Language/Country/Time

The following options are available from the [Configuration | System | Language/Country/Time](#) menu:

- System language of the Solar-Log™.
- Country/Location of the Solar-Log™.
- System time of the Solar-Log™.
- Time synchronization.

Language section

Procedure:

- Select the desired [Language](#) in the selection menu.
The selected display language applies both to the display and the web browser.
- [SAVE](#) the settings.

Country section

Procedure:

- Select your [Country](#) in the selection menu.
The country setting affects how the date, time and currency formats are displayed.
- [SAVE](#) the settings.

Time section

Solar-Log™ has an integrated real-time clock which can maintain the clock time even in the case of a power failure or grid disconnection, and for a long period (50 days).

The clock time is factory-set, but it may be lost due to long periods of storage.

The time zone, date and summertime values must be set correctly, so that no incorrect statuses or results are obtained during monitoring and graph display.

Fig.: Configuring the time on the Solar-Log™

Adjust the time in the [Configuration | System | Language/Country/Time](#) menu.

Adjust the new system time

Procedure:

- The current system time is displayed.
- Enter the following format to change [the date and time](#):
DD/MM/YY HH:MM:SS
For example: 28.08.19 14:44:04 for 28 August 2019 14 Hours 44 Minutes 04 seconds
- [SET](#) a new date and time.

Adjust the time zone

Procedure:

- Enter the time difference in hours (time zone).
Default: GMT +1.
- Save the entry .

Set Day Light Saving Time

Procedure:

- Select the corresponding Day Light Saving Time settings:
Options: no, CEST (Central European Summer Time), USA, Australia.
- SAVE settings.

Automatic time synchronization section

To automatically synchronize the system time, the Solar-Log™ regularly contacts a network time protocol (NTP) server.

If the Solar-Log™ is connected to the internet via a router, the synchronization occurs during the night.

Procedure:

- Activate the Automatic time synchronization button.
- SAVE the settings.

Update now function, the time synchronization with the NTP server can be manually started. The NTP port 123 needs to be enabled in the gateway or firewall.

20.4 Licenses

Certain Solar-Log™ functions have to be activated by entering a license code. You receive a license certificate after purchasing a license for a particular function. The licenses are always linked to the serial number of the particular Solar-log™ and can only be used with the device with this serial number.

Perform the following steps to purchase a license:

- Go to the license portal at <https://solar-log.shop/en-gb/lizenzen>
- Log on with your Enerest account.
- After you have enter the serial number of the Solar-Log™, a list of compatible licenses is displayed.
- You can only select one license from the list. After the selection has been made, the web-shop payment options appear.
- After the payment confirmation, the license is valid.

Automatic import:

- Go to the Configuration | System | Licenses WEB menu of the Solar-Log™.
- Click on Synchronize.
- Now the Solar-Log™ connects to the license server and downloads all of the active licenses.

Manual import:

- Download the license file from the License portal.
- Go to the Configuration | System | Licenses WEB menu of the Solar-Log™.
- Click on the plus symbol and select the license file.

After importing the license, it is activated immediately and "Installed" is displayed.

Note



Licenses are linked to a device (serial number). If a device is replaced, the license must be purchased again. Recognized warranty cases are excluded from this regulation.

Note



If a Solar-Log™ with a license has a defect during the warranty period, a license can be requested for the replacement device. There are no costs involved, provided that the defective device is returned to Solar-Log GmbH.

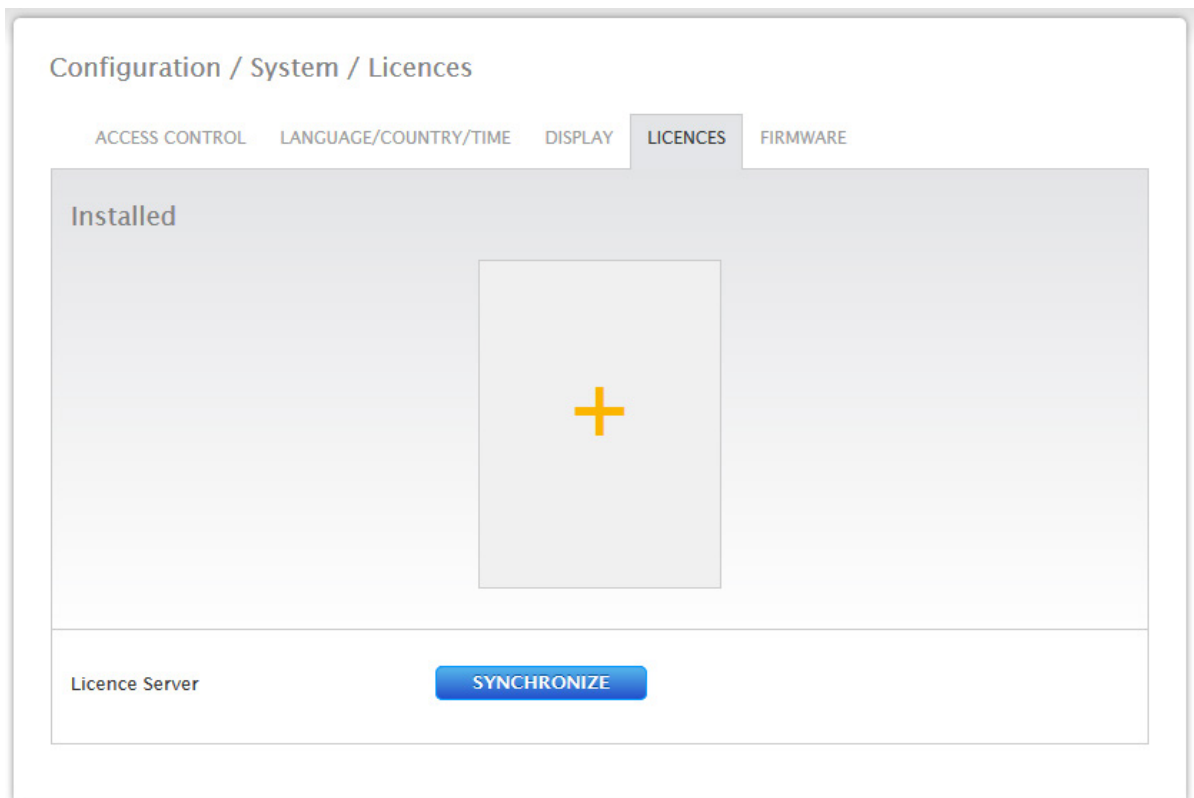

Fig.: Solar-Log™ with license section

20.5 Firmware

The firmware tab offers the following functions:

- Information about the current firmware version.
- Firmware update options.

Status section

The firmware version currently installed on the Solar-Log™ is displayed. The version number contains three sections:

Version number	Build	Date
6.0.0	Build 160 -	27.01.2023

Updating firmware manually section

This function allows a new firmware to be imported from a disk.

Note



Before manual updating, it is important to save the current system data and make a backup.

Note



Clear the browser's cache after updating the firmware to prevent any possible display errors.

Procedure:

- Click on **Browse**.
- The file manager of your OS appears.
- Select the firmware file that is to be imported.
- The selected firmware's **file name** is displayed.
- Click on **Upload**.
- Then you are asked if system and data backups have been made. If you click "Cancel" on these queries, the process is aborted.
- The progress and status of the update are displayed.
 - Upload the file
 - Finish current measurement.
 - Restart.
 - Unzip the file.
 - Restart.
- The Solar-Log™ reboots itself.
- The **Current Firmware Version** is shown in the display and in this menu.

Check for Update from the Internet section

With this function, the Solar-Log™ contacts the Solar-Log GmbH firmware servers to check if a new version is available and offers to install it.

Check for Update from USB

With this function, the Solar-Log™ checks the USB stick connected directly to the device if a new version is available.

When this function is used, the progress and status of the update are displayed:

- Select current measurement and
- the USB storage device.

Check Firmware Version automatically

With this function, the Solar-Log™ continuously checks whether a newer version of the firmware is available on the update server and offers it for installation.

Note



By activating this function, you give Solar-Log GmbH permission to automatically load minor updates. This function is not intended to replace manual firmware updates.

21 Diagnostics Menu

Click on Diagnostics in the tool bar to access the Diagnostics menu.

The following options can be selected from the [left-side navigation](#) menu:

- Inverter Diagnostic.
- Event log.
- Feed-In Management chapter of the Installation Manual.
- SCB Monitor (only when SCB active).

21.1 Inverter Diagnostic

To access the Inverter diagnostic menu, go to [Diagnostic | Inverter Diagnostic](#).

The following tabs can be selected from this menu:

- Inverter details,
- Tracker comparison and
- Module field comparison.

Different values with different units are displayed in the following diagnostic graph. A key is displayed for every graphic to define which units are used and their colors.

21.1.1 Inverter details

To access the Inverter details menu, go to [Diagnostic | Inverter Diagnostic | Inverter details](#).

A particular date and device (e.g. inverter or sensor) can be selected under inverter details and evaluated.

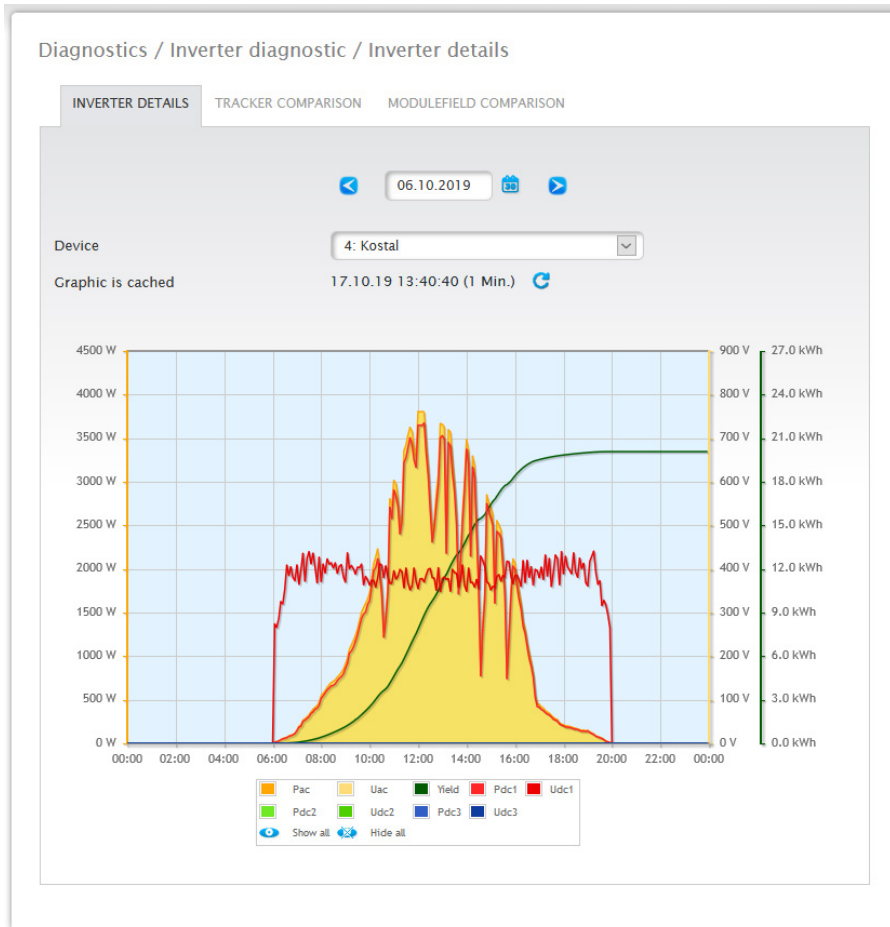

Fig.: Inverter details graph

In the example (see Fig.: Inverter details graph), the following values for the inverter can be displayed:

- Pac
- DC power 1
- DC power 2
- DC power 3
- Yield
- DC voltage 1
- DC voltage 2
- DC voltage 3
- AC voltage (Uac) – this value is displayed if the inverter supports this function).

All of the values displayed in the key can be selected and deselected at anytime with a left-click to display individual values (curve) or to display or hide all values (curves). With a right-click, all of the values (curves) other than the one selected can be hidden.

21.1.2 Tracker comparison

To access the Tracker comparison menu, go to [Diagnostic](#) | [Inverter Diagnostic](#) | [Tracker comparison](#). Two trackers (either from the same device or two different devices) can be compared on a particular date by selecting the date, device and tracker.

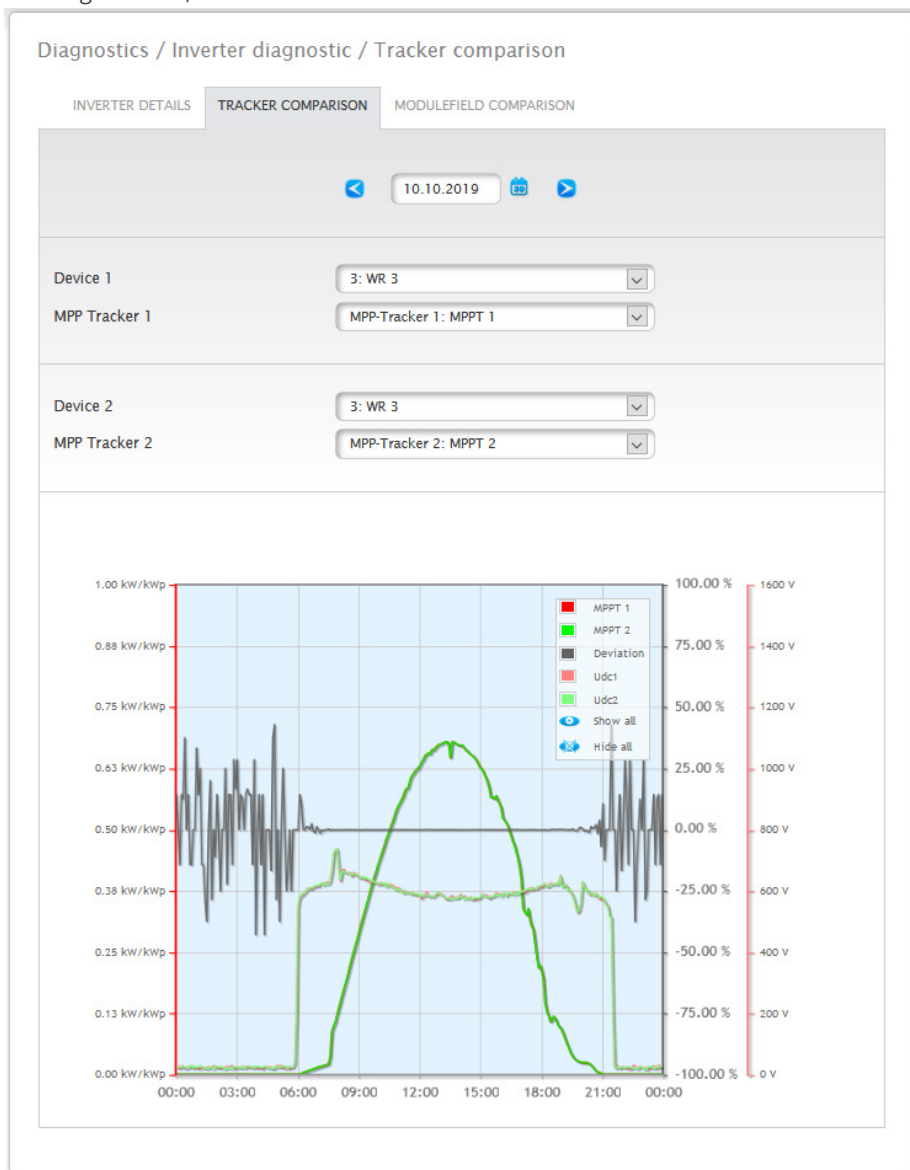

Fig.: Tracker comparison graph

In the example (see Fig.: Tracker comparison graph), two different inverters have been selected and evaluated. The better view has been selected for the DC voltage 1 and 2 values.

The two strings from inverter 3 and 1 are directly compared to each other.

The gray line displays the degree of deviation. The deviation as a percentage is indicated in the right column, and displayed as a positive or negative percentage. In the example, the deviation between the strings is from about -5% to +5%. The column on the left indicates the kW/kWp output of the tracker. All of the values displayed in the key can be selected and deselected at anytime with a left-click to display individual values (curve) or to display or hide all values (curves). With a right-click, all of the values (curves) other than the one selected can be hidden.

21.1.3 Module field comparison

To access the Module field comparison menu, go to Diagnostic | Inverter Diagnostic | Module field comparison.

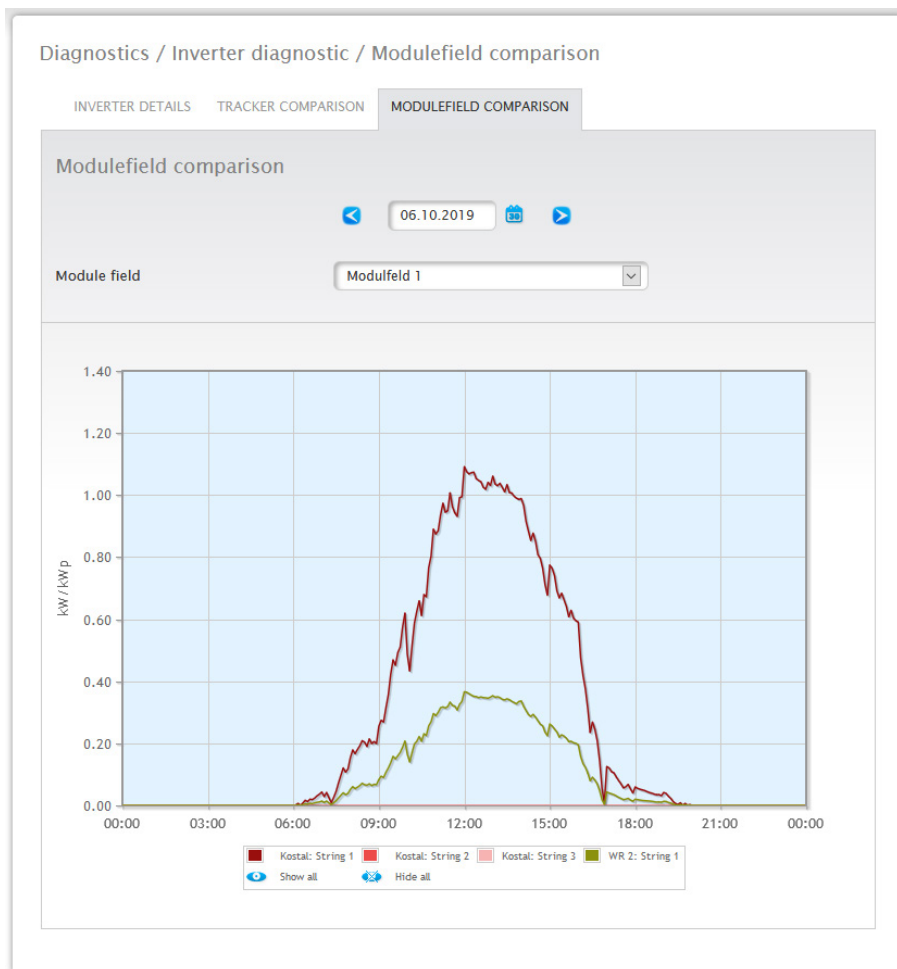

Fig.: Module field comparison graph

With the **Date** and **Module Field** boxes, the module field comparison permits all devices (e.g. inverters and sensors) and their strings that are assigned to the same module field to be compared on the current and previous days (see Fig.: Module field comparison graph) in order to more efficiently detect faults from the performance monitoring.

In the example graph, the following values are displayed:

- Sensorbox (S 4).
- INV 1; INV 2.

All of the values displayed in the key can be selected and deselected at anytime with a left-click to display individual values (curve) or to display or hide all values (curves). With a right-click, all of the values (curves) other than the one selected can be hidden.

Note



Only a maximum of 50 curves can be displayed.

21.2 Battery Diagnostic

To access the Battery diagnostic menu, go to [Diagnostic | Battery Diagnostic](#).

The following tabs can be selected from this menu:

- Current Measurement Values
- Charging History 1-Day.
- Charging History 7-Days.
- Balances.

21.2.1 Current Measurement Values

The following values are available from the [Current Measurement Values](#) tab:

- Battery voltage (V):
The current voltage of the battery.
- Charge Level (%):
The current charge status of the battery as percentage.
(The charge level for power meters in battery meter mode is currently not set.)
- Current charging power (W):
The battery's current amount of charge in watts.
- Current power output (W):
The discharge output in watts.

Diagnostics / Battery diagnostic / Current measurement values			
CURRENT MEASUREMENT VALUES			
CHARGE HISTORY 1 DAY			
CHARGE HISTORY 7 DAYS			
BALANCES			
Current measurement values			
Status	188		
SOC	67	%	?
Current charging power	1980	W	
Current discharging power	0	W	

Fig.: Battery diagnosis - Current measurement values

21.2.2 Charging History 1-Day

A daily graph with the following values is in the Charging History 1-Day tab.

- Charge:
The battery's charge levels throughout the day in watts.
- Discharge:
The battery's discharge levels throughout the day in watts.
- Charge Level (%):
The battery's charge levels throughout the day as a percentage.
- U (V):
The battery's voltage curve throughout the day in volts.

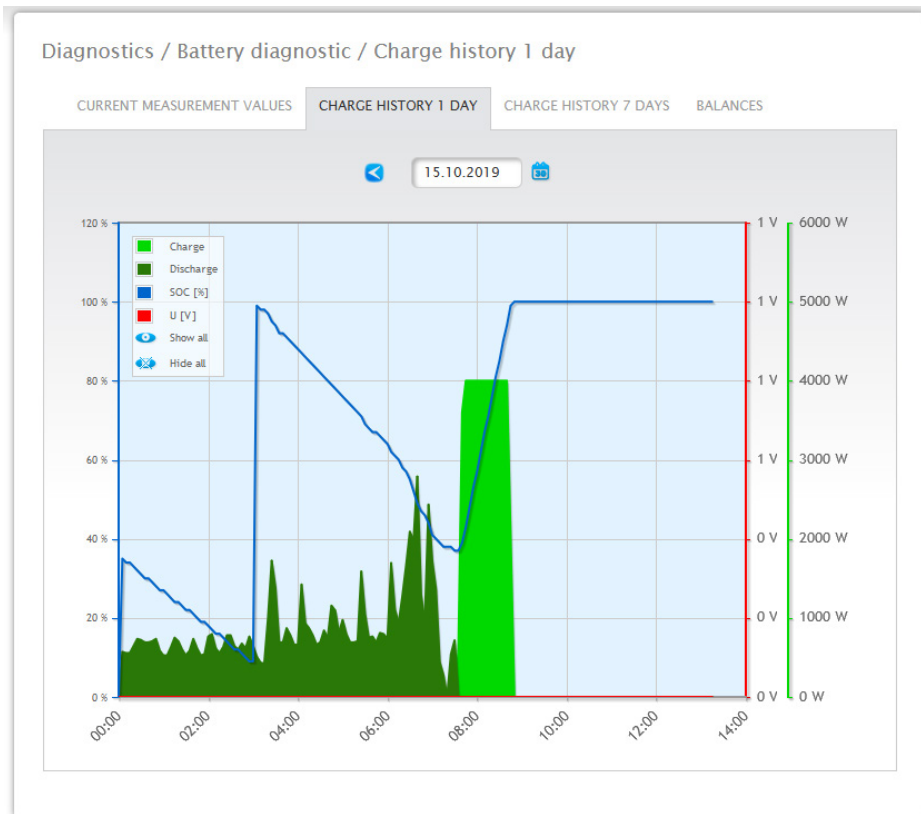

Fig.: Battery diagnosis - Charging History 1-Day

The **Date** box offers the option to select a particular day for viewing. The arrow keys can also be used to move to the next or previous date.

The individual values, at the top-left of the graph key, can be displayed or hidden with a mouse click.

21.2.3 Charging History 7-Days

A graph containing the last seven days with the following values is in the **Charging History 7-Days** tab.

- **Charge:**
The battery's charge levels from the last 7 days in watts.
- **Discharge:**
The battery's discharge levels from the last 7 days in watts.
- **Charge Level (%):**
The battery's charge levels from the last 7 days as a percentage.
- **U (V):**
The battery's voltage curve over the last 7 days.

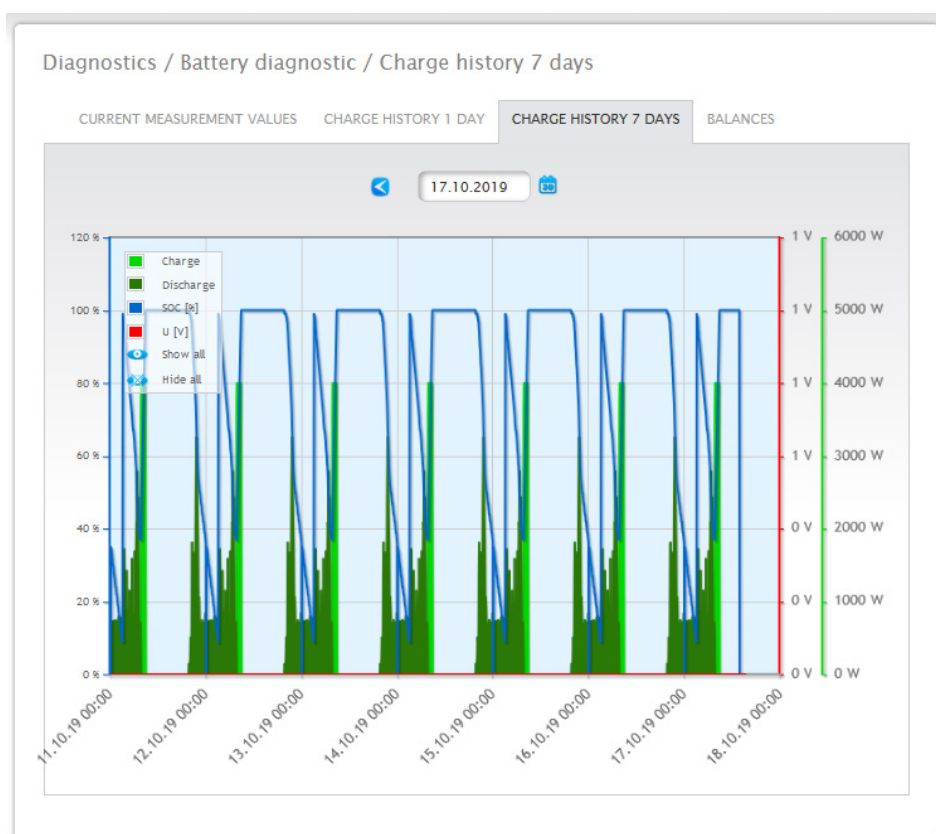

Fig.: Battery diagnostic - Charging History 7-Days

The **Date** box offers the option to select a particular 7-day period for viewing. The arrow keys can also be used to move to the next or previous date.

The individual values, at the top-left of the graph key, can be displayed or hidden with a mouse click.

If needed, click on the **interrupt** button to stop loading the data.

21.2.4 Balances

The following sections are in the **Balances** tab:

- Electricity savings from battery usage.
- Battery efficiency.

Electricity savings from battery usage section

The following columns are in this section:

- Discharge:
The battery's discharge during its entire run-time in kWh.
- Electricity costs saved:
The electricity savings from battery usage during its entire run-time in the defined currency.

Battery efficiency section

The following columns are in this section:

- Charge:
The battery's charge during its entire run-time in kWh.
- Discharge:
The battery's discharge during its entire run-time in kWh.
- Efficiency values:
The battery's efficiency values during its entire run-time as a percentage.

Diagnostics / Battery diagnostic / Balances

CURRENT MEASUREMENT VALUES CHARGE HISTORY 1 DAY CHARGE HISTORY 7 DAYS **BALANCES**

Power saving from battery usage	
Discharge	65.772 kWh
Electricity costs saved	0.00 €

Battery efficiency	
Charge	27.078 kWh
Discharge	65.772 kWh
Efficiency value	242.90 %

Fig.: Battery diagnosis - Balance

21.3 Accessing Event logs

To access the Event logs menu, go to Diagnostic | Event logs.

The following mode is loaded when accessing the event logs.

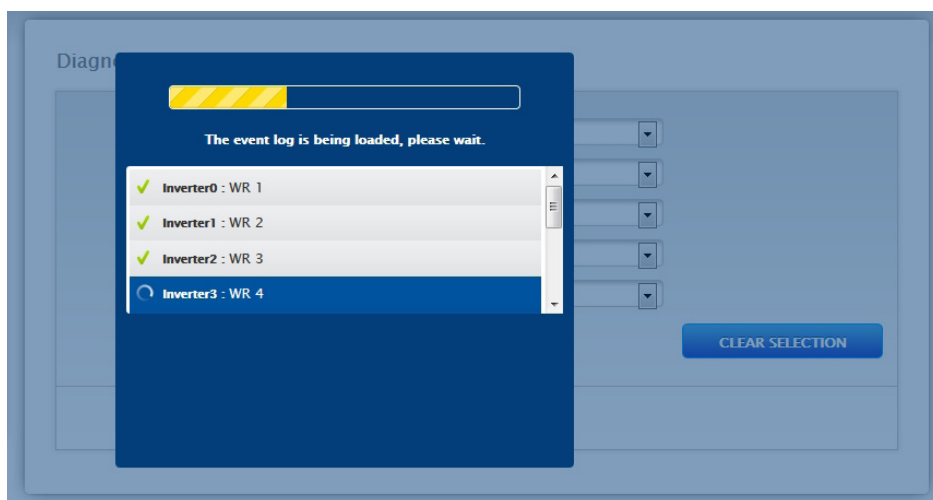

Fig.: The event log is being loaded.

After the event log is available, the mask changes to the standard view.

The following settings are available from the four drop-down menus in this view:

- Devices:

Under devices, you can select individual devices or leave the default selection as is (default "All devices").

- Days:

Under days, you can select individual days or leave the default selection as is (default "All days").

- Status codes:

Under status codes, you can select individual status codes or leave the default selection as is (default "All status codes").

- Fault codes:

Under fault codes, you can select individual fault codes or leave the default selection as is (default "All fault codes"). By default, the current day is displayed in the table with all devices, fault codes and status codes.

21.4 Accessing Feed-In Management

To access the Feed-In Management menu, go to Diagnostic | Feed-In Management.

Note!



The menu Feed-In Management under Diagnostic | Feed-In Management only appears if active power has been configured in the Configuration | Feed-In Management section.

Diagnosis / Feed-In Management / Control state

CONTROL STATE FEED-IN BALANCE UTILITY METER PM-HISTORY

Control state

Power reduction

Reduction type determined by: PMC_INTERN

Reduction type: PMF_NONE

Value determined by: PMV_MODE

Target power output (%DC): 100

	RS485/422-C	Total
Generator power (kW)	285.00	285.00
Maximum AC power (kW)	220.00	220.00
Allowed power (kW)	285.00	285.00
Consumption (kW)	114.17	114.17
Control value AC power (kW)	220.00	---
Current power output (kW)	147.01	147.01
Control value power (% AC)	100.00	---
Current power output (% AC)	66.82	66.82
Feed-in power (% DC)	11.52 !	11.52 !

Reactive power control

Reactive power determined by: PMC_INTERN

Reactive control type: PMF_RP_MATRIX

Value determined by: PMV_RP_PIGGY

Secondary type of reactive power control: PMF_RP_NONE

Secondary value determined by: PMV_NONE

Cos(Phi): 1.000

Reactive power (VAr): 0 kapazitiv

Fig.: Feed-In Management - Control State

The inverter control can be analyzed and adjusted in the [Diagnostic | Feed-In Management](#) settings section.

There is also a [10% Diagnosis Function](#) to simulate a dynamic reduction to 10%.

The values are displayed in the table.

Note!



The 10% Diagnosis Function can only be used when the 70% Fixed Reduction has been activated.

21.4.1 Explanation of the Values in the Power Reduction Section

The following values are displayed in the Power Reduction section:

Power reduction type determined by:

The currently active control source is indicated in this field.

Displayed Text	Explanation Text
PMC_NONE	No control source.
PMC_DIAG	Controlled by the diagnostic mode.
PMC_MODBUS_2	Controlled by the ModBus PM V2 (new ModBusPM).
PMC_MODBUS_1	Controlled by the ModBus PM V1 (old ModBusPM).
PMC_PROFILE	Controlled by the PM Profile.
PMC_INTERN	Controlled by the internal configuration.
PMC_DM_MODBUS	Controlled by direct seller via ModBusDM.
PMC_DM_RCR	Controlled by direct seller via ripple control receiver

Type of Reduction:

This contains the current type of power reduction that is specified by the control source.

Displayed Text	Explanation Text
PMF_NONE	No power reduction function.
PMF_PR_ERROR	An error occurred while determining the power reduction function.
PMF_PR_FIX_PERC	Fixed reduction at % DC.
PMF_PR_FIX_KW	Fixed reduction at X kW (AC)
PMF_PR_VAR_PERC	Fixed reduction at % DC with self-consumption calculation.
PMF_PR_VAR_KW	Fixed reduction at X kW (AC) with self-consumption calculation.
PMF_PR_FIX_MATRIX	Reduction based on the value from the matrix (ripple control receiver configuration).
PMF_PR_VAR_MATRIX	Reduction based on the value from the matrix (ripple control receiver configuration) with self-consumption calculation.

Value specification from:

This field indicates how the control value used was determined.

Displayed Text	Explanation Text
PMV_NONE	No control source.
PMV_CONFIG	The value is stored in the configuration.
PMV_MODE	The value can be determined by the reduction mode.
PMV_PR_PIGGY	The value comes from the PM (power reduction) input (and is determined in combination with the matrix in the configuration or PM profile).
PMV_MPR_PIGGY	The value comes from the PM (power reduction) input of the master (and is determined in combination with the matrix in the configuration or PM profile).
PMV_MODBUS_1	The value comes from the ModBus PM V1 interface.
PMV_MODBUS_2	The value comes from the ModBus PM V2 interface.
PMV_PROFILE_ADAM	The value comes from the analog or digital input of the IO Box (Adam Box).
PMV_PROFILE_INTERN	The value is specified in the PM profile.
PMV_ERROR	An error occurred while determining the value.
PMV_CONFIG_UTILITY	The value was determined via the internal configuration based on the Utility Meter measurement.
PMV_MODBUS_DM	The value comes from the ModBus DM interface (direct seller interface).

Target power output %:

The fields indicate the percentage of the Plant's DC power determined by the control for the target output.

The detailed values for the individual bus connections and for the total plant are displayed in the following table below. The individual buses (RS485 A-C) are displayed depending on which bus is assigned to control the inverters.

The column **Total** always corresponds to the plant total and reflects the value from the grid connection point. The consumption values are displayed in all of the columns, but only the plant total is taken into account.

Note!

The values from the individual inverters are calculated per bus and for the entire plant.

Generator power (kW):

The generator power corresponds to the module output of the inverter that is connected to this data bus. This value results from the total of the partial outputs entered in the field generator power under Configuration | Devices | Configuration. This kW value is used when calculating the output reduction (e.g.: the 70% reduction).

Maximum AC power (kW):

The maximum AC power of the inverter(s) depends on the device. Refer to the inverter specifications for this value and configure it in the field Maximum AC power under configuration | Devices | Configuration.

Allowed power (kW):

This kW value is the maximum amount of power that is allowed at the grid connection point. The value is calculated based on the generator output and the current power output.

Consumption (kW):

This value is calculated from the consumption meters and refers to the entire plant. The values displayed in the respective bus column only refer to the plant total and are not taken into account in the corresponding columns. The consumption value is normally subtracted from the allowed power from the entire plant.

Control value power (kW):

This value is calculated by the Solar-Log™ and is the maximum current power output from the inverters. It is used for the current target power output.

Note!

Due to technical reasons, the calculation from the Solar-Log™ is subject to a rounding factor. This may lead to deviations in the data recording.

Current power output (kW):

The value refers to the current output generated by the inverter per interface (column) and for the entire plant.

Control value power (% AC):

The Solar-Log™ calculates the control value power (kW) as a percentage of the maximum AC power and relays this to the inverters.

Current power output (AC%):

The value indicates the total output generated as a percentage of the maximum AC power for the inverter or all of the inverters on a bus.

Feed-in power (% DC):

This value is the current amount of feed-in power as a percentage of the generated output.

21.4.2 Explanation of the Symbols in the Feed-in power (% DC) column:

The feed-in power value is in the target power range with a tolerance of -2% to +1%.



The feed-in power value is below the target value allowed. Generally, this means that the output allowed at the grid connection point is not being achieved due to low irradiation or high self-consumption.



This means that the value is above the target value allowed.

If the red triangle is only displayed at a bus and entire plant has a green symbol, this means that only this bus is over the target value allowed. However, the plant totals do not go over the target value because of self-consumption.

21.4.3 Explanation of the Values in the Reactive Power Reduction Section

The following values are displayed in the Reactive Power Reduction section:

Reactive Power determined by:

The currently active control source is indicated in this field.

Displayed Text	Explanation Text
PMC_NONE	No control source.
PMC_DIAG	Controlled by the diagnostic mode.
PMC_MASTER	Controlled by Master Solar-Log™
PMC_MODBUS_2	Controlled by the ModBus PM V2 (new ModBusPM).
PMC_MODBUS_1	Controlled by the ModBus PM V1 (old ModBusPM).
PMC_PROFILE	Controlled by the PM Profile.
PMC_INTERN	Controlled by the internal configuration.
PMC_DM_MODBUS	Controlled by direct seller via ModBusDM.
PMC_DM_RCR	Controlled by direct seller via ripple control receiver

Type of Reactive Power Reduction:

This contains the type of reactive power reduction that is specified by the active control source.

Displayed Text	Explanation Text
PMF_RP_NONE	No reactive power control.
PMF_RP_ERROR	An error occurred while determining the reactive power control function.
PMF_RP_FIX_COS	Fixed Cos(Phi) specification.
PMF_RP_FIX_Q	Fixed reactive power specification.
PMF_RP_Q_U_LINE	Reactive power determined by the characteristic curve Q(V)
PMF_RP_P_PN_LINE	Cos(Phi) determined by the configured characteristic curve P/Pn
PMF_RP_ADJUSTABLE	The control function is determined by an input (e.g. via a ripple control receiver or IO Box/Profile).
PMF_RP_MATRIX	The Cos(Phi) specifications are determined by the the configured matrix.

Value specification from:

This field indicates how the control value used was determined.

Displayed Text	Explanation Text
PMV_NONE	No control source.
PMV_CONFIG	The value is stored in the configuration.
PMV_MODE	The value can be determined by the reduction mode.
PMV_RP_PIGGY	The value comes from the PM (reactive power control) input (and is determined in combination with the matrix in the configuration or PM profile).
PMV_MRP_PIGGY	The value comes from the PM (reactive power control) input of the master (and is determined in combination with the matrix in the configuration or PM profile).
PMV_MODBUS_1	The value comes from the ModBus PM V1 interface.
PMV_MODBUS_2	The value comes from the ModBus PM V2 interface.
PMV_PROFILE_ADAM	The value comes from the analog or digital input of the IO Box (Adam Box).
PMV_PROFILE_INTERN	The value is specified in the PM profile.
PMV_ERROR	An error occurred while determining the value.
PMV_CONFIG_UTILITY	The value was determined via the internal configuration based the Utility Meter measurement.
PMV_MODBUS_DM	The value comes from the ModBus DM interface (direct seller interface).
PMV_MASTER	The value can be determined by the Master Solar-Log™.

Secondary Type of Reactive Power Control:

If "PMF_RP_ADJUSTABLE" is entered as the "Type of Reactive Power Reduction," the variable assignment from the selected type of reactive power control is indicated in this field.

For example, a PM profile defines that the type of reactive power control is determined by the Adam Box. That means: The profile is responsible for the control. It is set up in the profile that the control can be selected via the Adam Box. The type of control selected is displayed under "Secondary Type of Reactive Power Control." The possible values are identical to those for "Type of Reactive Power Control."

Secondary value specification from:

When a secondary control is used, the source of the control value is indicated in this field. The possible values are identical to those for "Value specification from."

Cos(Phi):

The value defined in the [Configuration | Feed-In Management | Reactive Power Control](#) is displayed in this field.

Reactive power (Var):

The value defined in the [Configuration | Feed-In Management | Reactive Power Control](#) is displayed in this field.

21.4.4 Feed-balance section

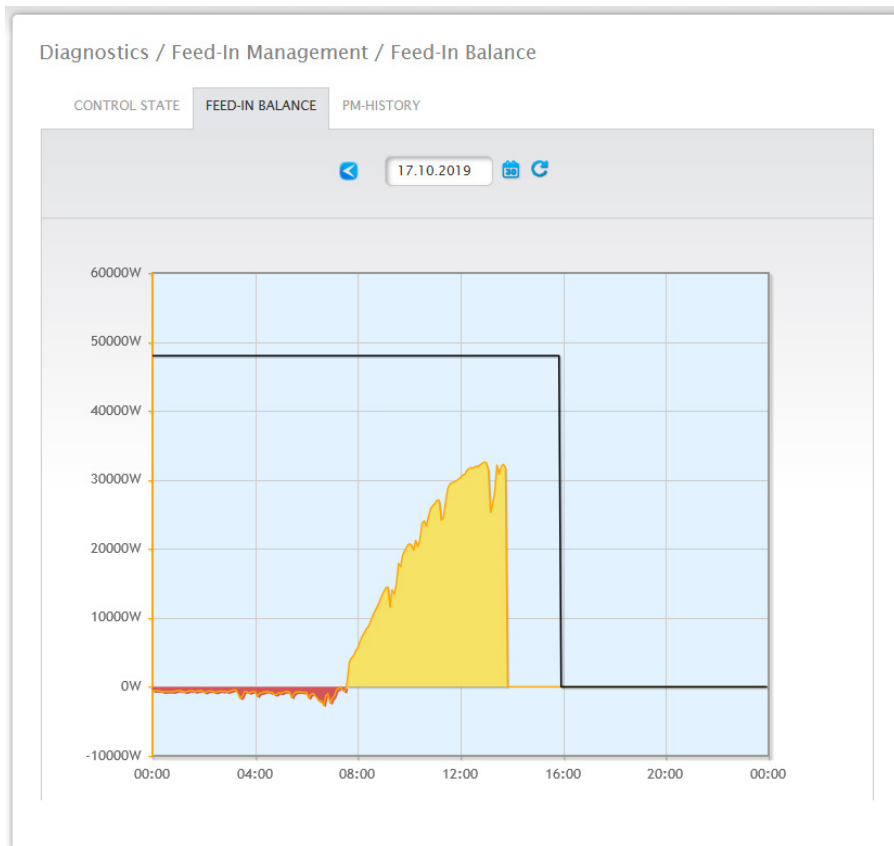

Fig.: Feed-In Management - Feed-balance

The **Feed-balance** tab displays when there was a grid feed and when electricity was purchased from the grid. Negative values mean that the power was purchased from the grid and positive values mean that power was fed into the grid.

Move the mouse cursor over the black line to display the following values for the power reductions:

- Time
- Percentage (%DC)
- Watt

21.4.5 PM History section

The power reductions are displayed in a table with three columns in the PM History tab.

Event from - to	Power reduction	Reduction type determined by
13.06.19 17:19:31 - 13.06.19 17:45:01	100%	PMC_INTERN
13.06.19 17:45:02 - 11.09.19 14:46:31	70%	PMC_INTERN
11.09.19 14:46:32 - 11.09.19 14:47:31	10%	PMC_DIAG
11.09.19 14:47:32 -	70%	PMC_INTERN

Fig.: PM History

- Event from - to:
 - The time and date that a power reduction was activated.
- Power reduction type determined by:

Possible values in this column:

 - PMC_NONE
 - PMC_DIAG
 - PMC_MODBUS_2
 - PMC_MODBUS_1
 - PMC_PROFILE
 - PMC_INTERN
 - PMC_DIRECTM

(For an explanation, refer to the section: "Explanation of the Values in the Power Reduction " in the table "Power reduction type determined by").
- Power reduction:
 - The power reduction as a percentage.

Two additional tabs can be accessed in the Feed-In Management menu (as long as the devices are connected):

- Utility Meter
- I/O Box

Detailed instructions in the Chapter [Configuration - Feed-in Management](#) below.

21.5 Accessing components

To access the Components menu, go to Diagnostic | Components.

The following tabs are available in the Components menu:

- RS485 Bus Analysis
- SO Meter (only visible when SO meter is connected)
- Wireless Package (only visible when the Wireless package is connected and has been activated)
- SCM Monitor (only visible when connected and the SCB license has been activated)

21.5.1 RS485 Bus Analysis

The RS485 bus analysis checks the RS485 bus communication and the associated value transmission. The interface, device and level have to be selected to perform an analysis. The higher the level, the more details that are in the results. However, it takes more memory and takes longer to process. When the settings are defined, the analysis can be performed by clicking on "Start Analysis." (see illustration)



Fig.: RS485 bus analysis with Janitza as an example (with installation mode active)

Once the analysis has been started, an inquiry is sent to the selected device. At the same time, the Solar-Log™ performs the bus analysis. The results (inquiry and response) can be viewed in the dialog (see previous illustration).

The view of the measured values can be enlarged and displayed in more detail using the mouse (either by holding down the right mouse button and dragging the cursor or using the mouse wheel). In the second part, you can also see which section of the measured value range you are currently in. Use the mouse cursor to control the section of the measured value range via the lower section. The measured values for RS485A-A or RS485A-B can also be displayed or hidden. (Refer to the illustrations below.)

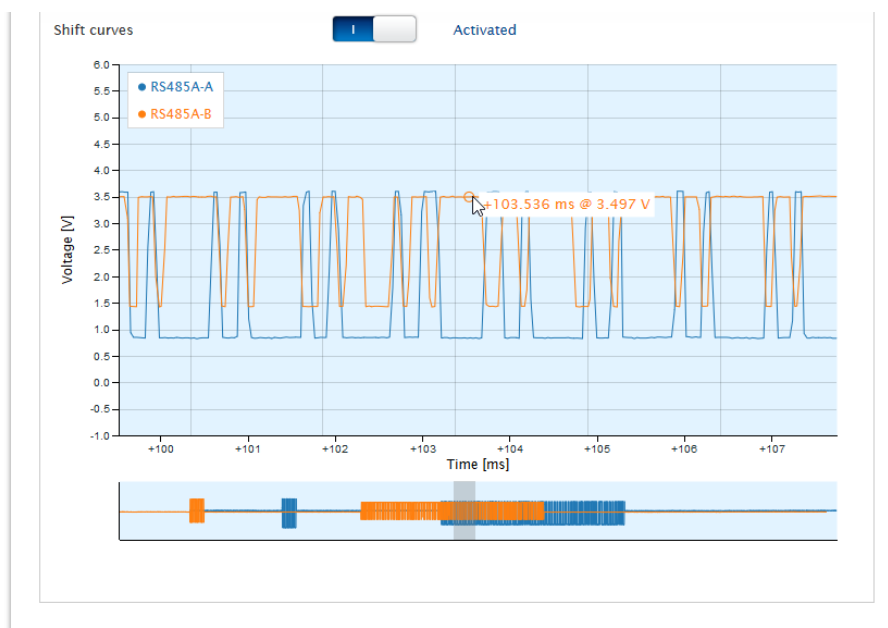

Fig.: Example segment section of the enlarged measured value range

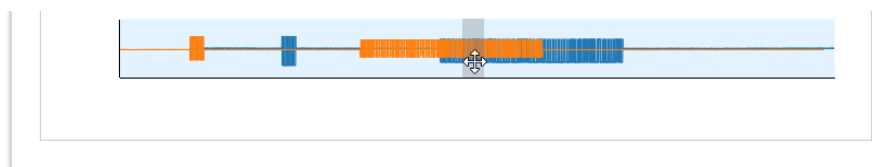

Fig.: Example segment section of the lower measured value range

Note!



Important for the analysis:

Due to technical reasons, the RS485A-A and RS485A-B channels are recorded with a time delay during the analysis. That is why it is normal to have a time delay for both curves. If the "Shift curves" check box is activated, the system corrects this time offset automatically.

21.5.2 Expansion module - Solar-Log MOD I/O

The status of the Solar-Log MOD I/O can be checked in the Diagnostics menu under “Expansion modules” (see illustration “Solar-Log MOD I/O - Solar-Log Base Communication bus/LED” and the corresponding sections below). With a mouse-over, you can see the real-time transferred values between the Solar-Log MOD I/O and the Solar-Log Base (see illustration “Communication between the Solar-Log MOD I/O and Solar-Log Base”).

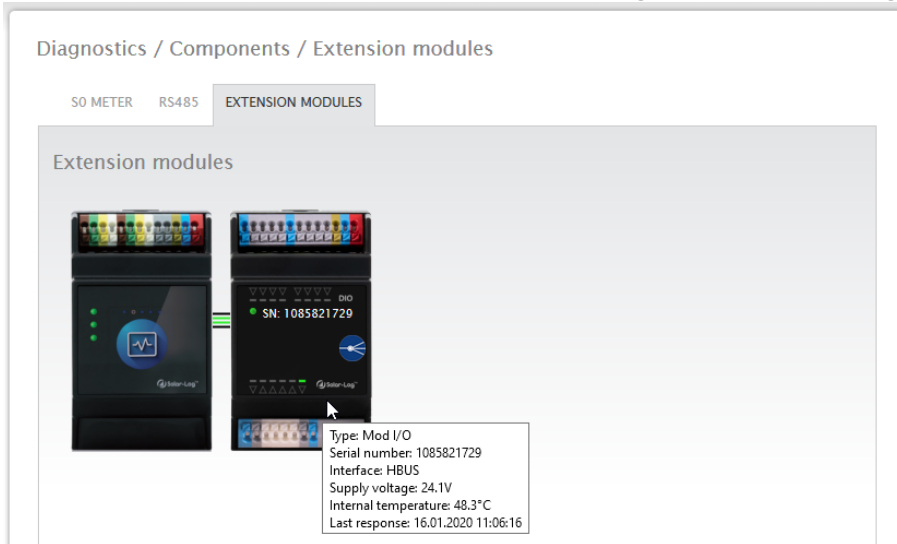

Fig.: Communication between the Solar-Log MOD I/O and Solar-Log Base

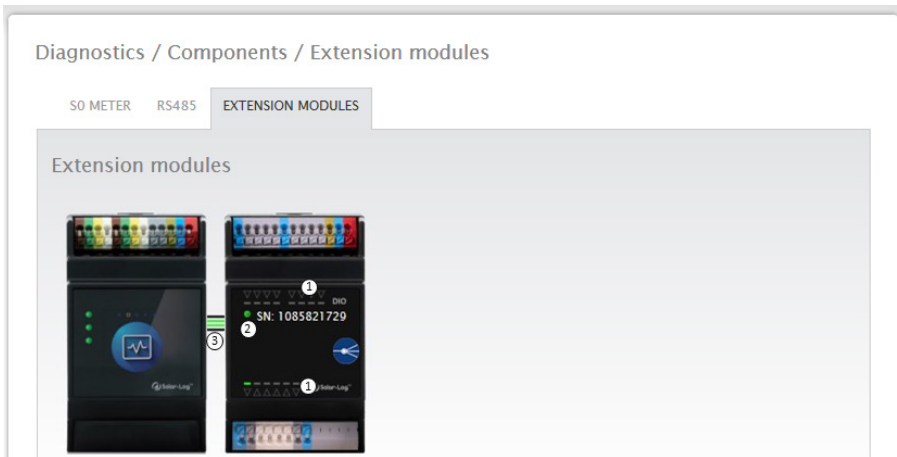

Fig.: Solar-Log MOD I/O - Solar-Log Base Communication bus/LEDs

Solar-Log MOD I/O - Solar-Log Base Connection Status

Inputs and outputs (see illustration under 1):

The LEDs indicate the current status of the inputs and outputs.

Communication between the Solar-Log MOD I/O and the Solar-Log Base (see illustration under 2):

LED (green): Everything is ok with the communication between the Solar-Log MOD I/O and the Solar-Log Base.

LED (orange/red): There is a communication problem between the Solar-Log MOD I/O and Solar-Log Base. This may cause limited functionality.

Communication via the communication bus (see illustration under 3):

The connectors between the Solar-Log MOD I/O and the Solar-Log Base indicate the current communication status for each individual function. Green means there is a connection and everything is ok.

There is a communication problem between the Solar-Log Base and Solar-Log MOD I/O, if one or more of these connectors are orange or red. This may cause limited functionality.

Note!

Please contact our support if the communication problem persists over a longer period.

21.5.3 Expansion module - Solar-Log MOD 485

The status of the Solar-Log MOD 485 can be checked in the Diagnostics menu under “Expansion modules” (see illustration “Solar-Log MOD 485 - Solar-Log Base Communication bus/LED” and the corresponding sections below). With a mouse-over, you can see the real-time transferred values between the Solar-Log MOD 485 and the Solar-Log Base (see illustration “Communication between the Solar-Log MOD 485 and Solar-Log Base”).

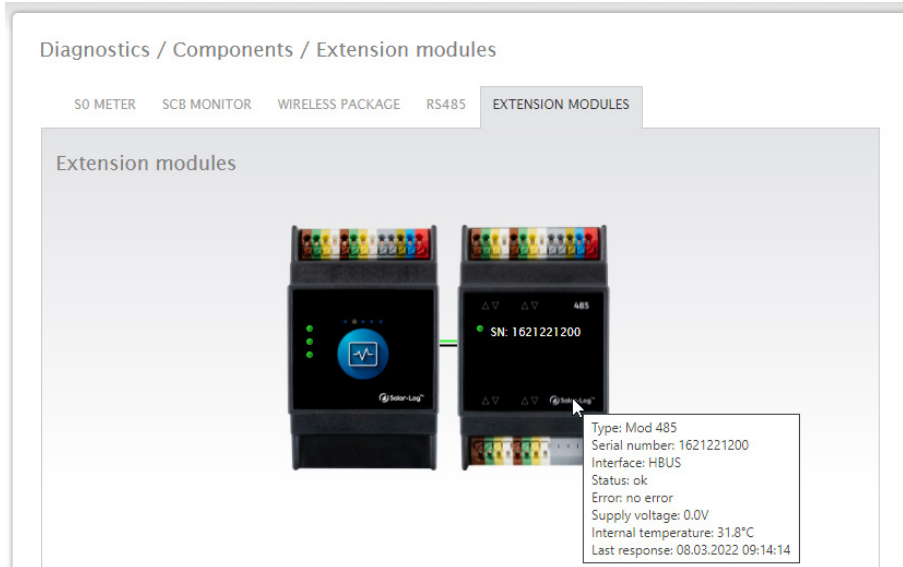

Fig.: Communication between the Solar-Log MOD 485 and Solar-Log Base

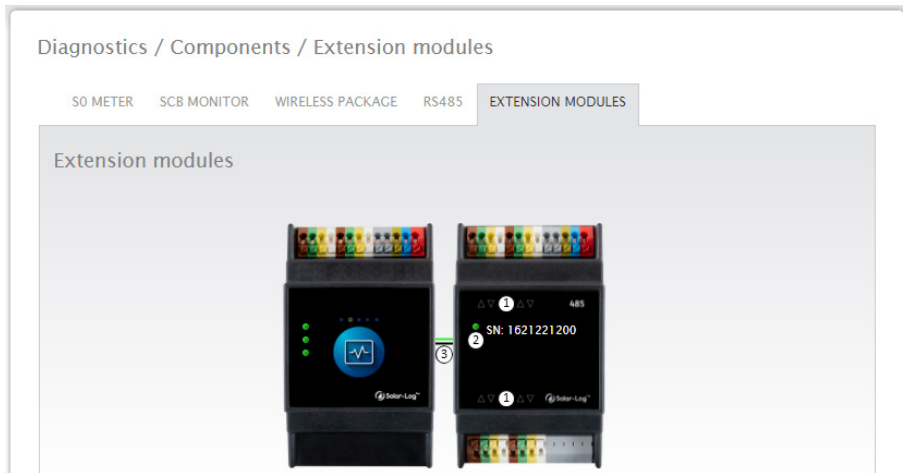

Fig.: Solar-Log MOD 485 - Solar-Log Base Communication bus/LEDs

Note



The Solar-Log MOD 485 can only be used with Solar-Log Base firmware 6.x or higher.

Solar-Log MOD 485 - Solar-Log Base Connection Status

Inputs and outputs (see illustration under 1):

The LEDs indicate the current status of the inputs and outputs.

Communication between the Solar-Log MOD 485 and the Solar-Log Base (see illustration under 2):

LED on top:

Green = Power on

LED middle:

Flashing green when there is traffic on the bus between Solar-Log and MOD485.

LED bottom:

Red during boot process of the MOD485.

During the boot process, the Solar-Log Base checks whether an update is necessary for the MOD485 module.

During the check the LED is red.

Boot process finished - no update necessary = LED goes to green

Boot process finished - update necessary and will be executed directly = LED goes to orange

Status of the update can be read via the arrow LEDs (all 8 LEDs on 100 %)

Communication via the communication bus (see illustration under 3):

The connectors between the Solar-Log MOD 485 and the Solar-Log Base indicate the current communication status for each individual function. Green means there is a connection and everything is ok.

There is a communication problem between the Solar-Log Base and Solar-Log MOD 485, if one or more of these connectors are orange or red. This may cause limited functionality.

Note!



Please contact our support if the communication problem persists over a longer period.

Note!



The LED arrows (see figure „Solar-Log MOD 485 - Solar-Log Base communication bus/ LEDs“ under 2) light up for the respective occupied interface.

- ▶ If the communication is OK, the LED arrows light up green.

21.5.4 SO Meter (only visible when connected)

All of the SO meters connected to the Solar-Log™ are listed in the [Diagnostic | Components | SO-Meter](#) menu. The following values are displayed in the Pulse meter box:

- Total number of pulses for the SO meter since the last restart of the Solar-Log™ (first number)
- Number of pulses since the menu has been accessed (second number)
- Pulse number interval in a minute (third number)

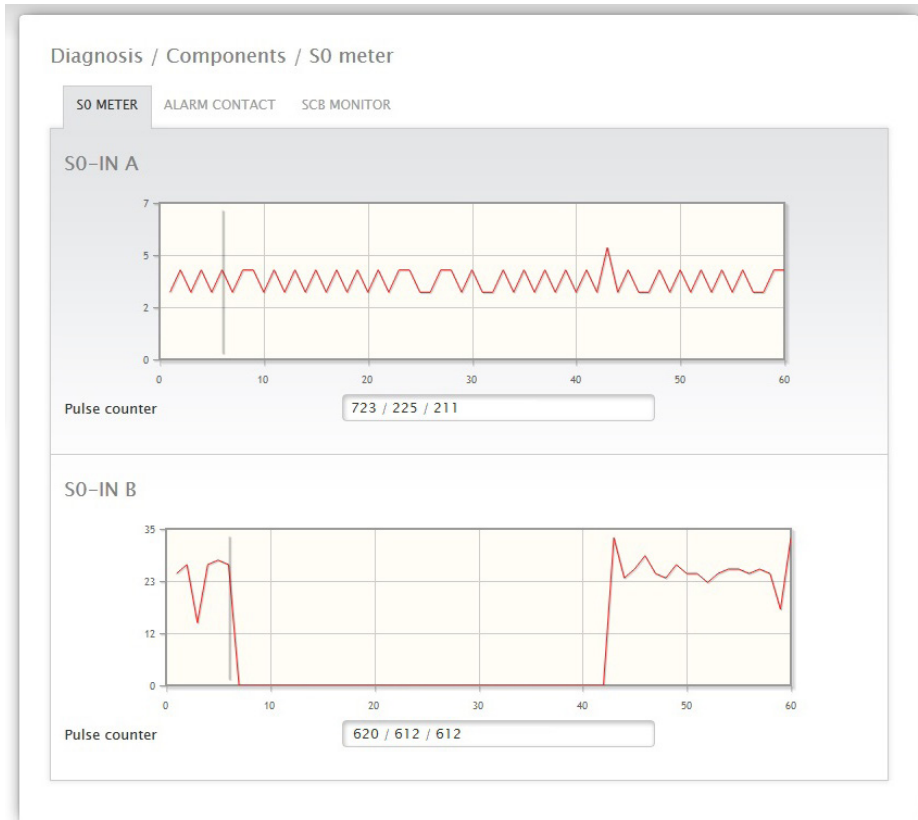

Fig.: Components - SO meter on interface A and B

Note!



The Solar-Log™ reorganizes the data every night so the total pulse counter of the SO meter is reset every night.

21.5.5 Wireless Package (only visible when activated)

You can access the Wireless Package test function from the [Diagnosis | Components | Wireless Package](#).

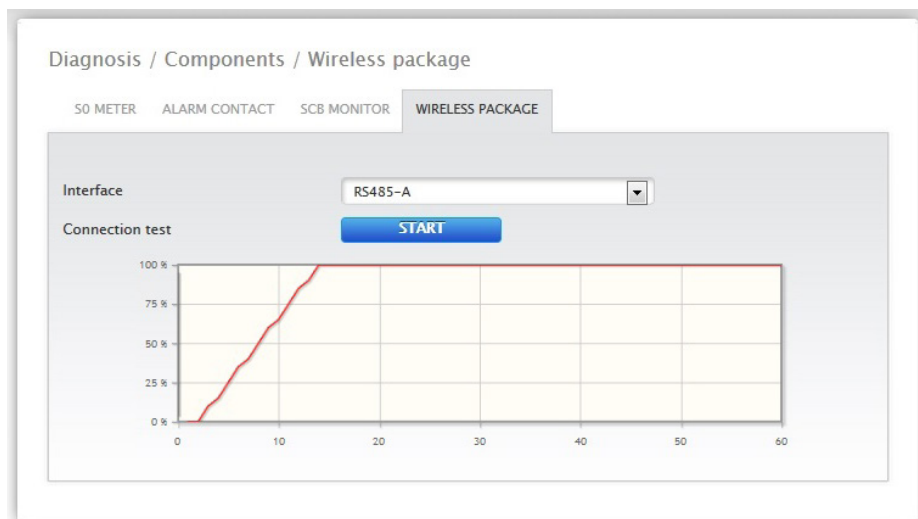

Fig.: Connection test - Wireless Package

To perform a connection test a Wireless Package has to be connected to the Solar-Log™, the interface with the Wireless Package has to be activated in the [Configuration | Devices | Definition](#) menu and the inverter has to be selected. Select the interface that the Wireless Package is connected to and press the Start button for the connection test.

The test is successful when the line goes to 100% percent and remains there.

Note!



Successful data transfers can only be guaranteed when the wireless connection is consistently at 100%.

21.6 Access SCM Monitor (only visible when SCB installation mode / license active)

To access the SCB Monitor menu, go to Diagnostic | Components | SCB Monitor.

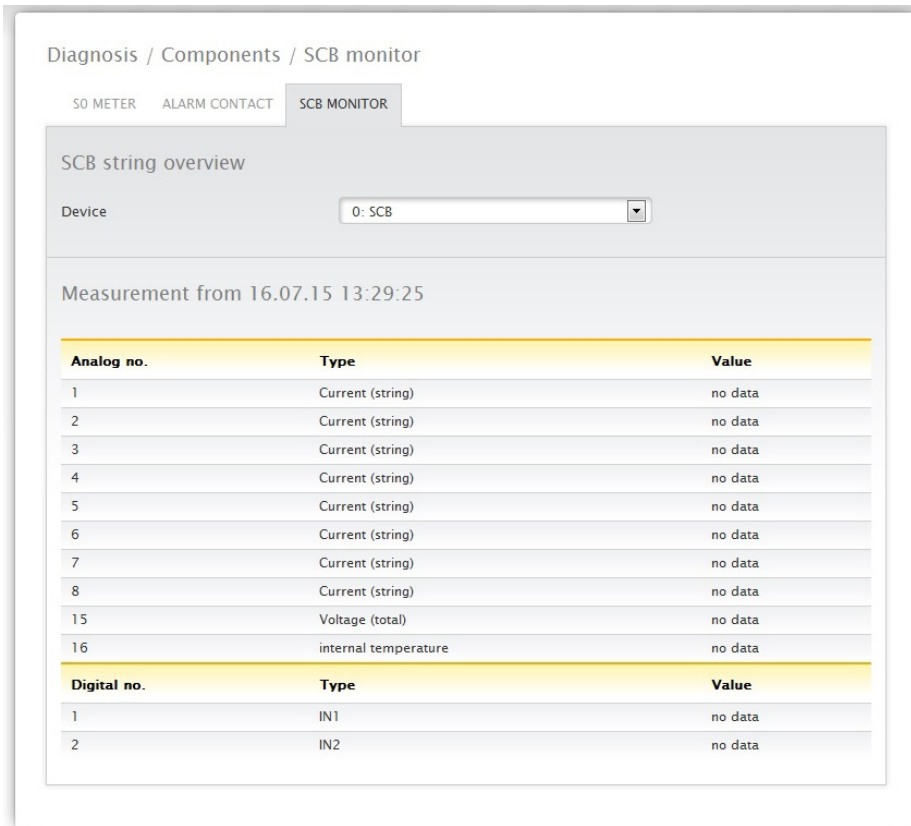

Diagnosis / Components / SCB monitor

SO METER ALARM CONTACT **SCB MONITOR**

SCB string overview

Device: 0: SCB

Measurement from 16.07.15 13:29:25

Analog no.	Type	Value
1	Current (string)	no data
2	Current (string)	no data
3	Current (string)	no data
4	Current (string)	no data
5	Current (string)	no data
6	Current (string)	no data
7	Current (string)	no data
8	Current (string)	no data
15	Voltage (total)	no data
16	internal temperature	no data

Digital no.	Type	Value
1	IN1	no data
2	IN2	no data

Fig.: Example of the SCB string overview

The **SCB String Overview** is displayed in a split-screen window. The connected devices (SCBs) can be individually accessed in the top screen via the pull-down menu.

The bottom screen displays the current measurements of the individual strings based on the analog and digital number.

Note!



Refer to the SCM manual for a detailed description.

21.7 Smart Energy

The following tabs are visible under the Smart Energy menu:

- Status (current)
- History
- Simulation

Status (current) section

The following values are displayed as a table in the **Status (current)** tab:

- Averaging (is visible when managing with average values)
- Total Plant
- Priority List:

There is also the option in this section to directly switch to the configuration of the Smart Energy switching group by clicking on the arrow symbol  in the top right corner.

21.7.1 Explanations of the terms

Averaging

The last time that the average value was calculated can be determined based on the countdowns in the averaging field.

Note!



The average value consists of the 5-, 10- or 15-minute average value depending on the number of connected inverters:

< 30 INV: 5 minutes, 30-59 INV: 10 minutes, >= 60 INV: 15 minutes

Internal processes, e.g. HTTP transmission or communication with the inverters, may cause a delay in the interval. In such cases, the countdown remains at "0" until the interval has been calculated.

Total Plant

The following values can be viewed under plant-wide:

- **Production:**
The production from the entire plant in watts. Current or average value (this value is recorded directly from all producers).
- **Consumption:**
The entire consumption in watts. Current or average value (this value is recorded directly from all consumption meters).
- **Remaining surplus:**
Surplus that is still fed into the grid. Current or average value (calculation [production - consumption]).
- **Smart Energy Consumption:**
This value is comprised of the nominal power or of the retrievable output from all of the currently active profiles and the current output from the controlled smart appliances. Current or average value.
- **Smart Energy Production (is only visible when at least one switching group is defined as a generator):**
The value indicates all of the current power output (e.g. CHP) that is currently active via the Solar-Log™. Current or average value.
- **Theoretical surplus:**
The theoretical surplus is the amount that would be fed into the grid if no Smart Energy logic was operating (including smart consumers). It is calculated accordingly: [(Production-Smart Energy Production)-(Consumption Smart Energy Consumption)]. Current or average value.

The selection for "Measurement values for control logic" under Configuration | Smart Energy | Surplus management determines whether the current values or average values are displayed for the status.

Priority List

The priority of the defined control logics are displayed under the Priority list. (See illustration: "Smart Energy Status (current)")

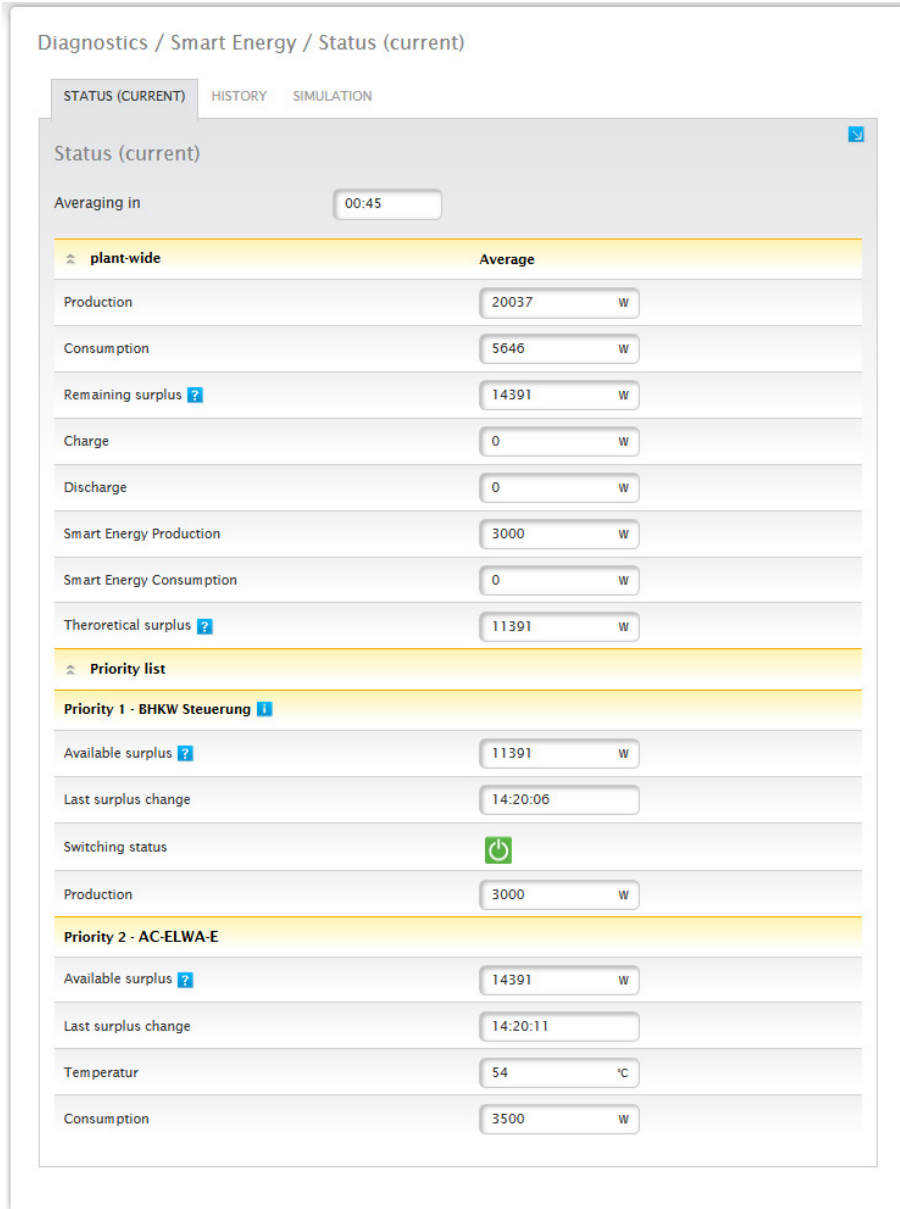

Fig.: Smart Energy Status (current)

Depending on the device or profile type selected, different information is displayed. For example: available surplus, runtime, temperature and charging states when a hybrid or battery system is connected. By clicking on the question mark the current configuration for the switching groups is displayed without switching to the configuration section.

21.7.2 History Section

Daily graphics, all of the configured control logics and the intelligent appliances are displayed according to their priority in the **History** tab. All of the relevant data for the particular device is displayed in the graphic. Each graphic has the curves "Total production," "Total consumption" and "Total surplus." This is identical for every graphic and is part of the overview with the plant-wide values. (See illustration: "Smart Energy History - Example with AC-ELWA-E - Surplus Priority 1"): All of the values displayed in the key can be selected and deselected at anytime with a left-click to display individual values (curve) or to display or hide all values (curves). With a right-click, all of the values (curves) other than the one selected can be hidden.



Fig.: Smart Energy History - Example of Priority 1

Depending on the connected device and configured control logic the labels may be different and also the values may vary (e.g.: runtime and switching status as well as charging states when a hybrid or battery system is connected).

Note!



The selected section can be enlarged by clicking on the graphic and dragging it.

Certain days can be selected to be viewed with the [Date](#) box. It is possible to scroll the dates back and forth with the arrow buttons. The individual values that are displayed at the top-left of the graph key can be explicitly displayed or hidden with a mouse click.

Basic View

The basic view can be activated with a button.

If this option is selected for a basic surplus rule in which all of the contacts are switched together only the curves of the first contact are displayed in order to maintain a clear overview in the graphic.

There is the option to directly switch to the configuration of the Smart Energy switching group by clicking on the arrow symbol  in the top right corner.

21.7.3 Simulation Section

The configured control logics can be simulated under the Simulation tab to check if the logics are correct. The simulation is always based on the the underlying calculated averages.

(See the example Figure: "Smart Energy - Simulation with AC-ELWA-E - Surplus Priority 1").



Fig.: Smart Energy - Simulation with AC-ELWA-E - Surplus Priority 1

Similar to the History view, there are various values displayed in the graphic view. These values depend on the particular connected device and/or configured control logic.

All of the values displayed in the key can be selected and deselected at anytime with a left-click to display individual values (curve) or to display or hide all values (curves). With a right-click, all of the values (curves) other than the one selected can be hidden.

In the simulation, different view options can be selected for the production and consumption curves.

The following options can be selected:

- Production curve
 - Zero line
 - Increasing
 - Decreasing
 - Constant (a fixed value in watts can be defined here)
 - Normal levels of irradiation
 - Very high levels of irradiation
 - Low levels of irradiation
 - Inconsistent levels of irradiation
 - Selected day (a particular day can be selected here)
- Consumption curve
 - Zero line
 - Increasing
 - Decreasing
 - Constant (a fixed value in watts can be defined here)
 - Normal
 - Smooth
 - Jagged
 - Selected day (a particular day can be selected here)

There is the option to directly switch to the configuration of the Smart Energy switching group by clicking on the arrow symbol  in the top right corner.

Note!



For more information on Smart Energy (such as configuration, functionality and application examples), refer to the Chapter: "Menu Configuration - Smart Energy" or go to our website <https://www.solar-log.com/en/support/download-area/manuals>

21.8 Accessing Support

To access the Support menu, go to Diagnostic | Support.

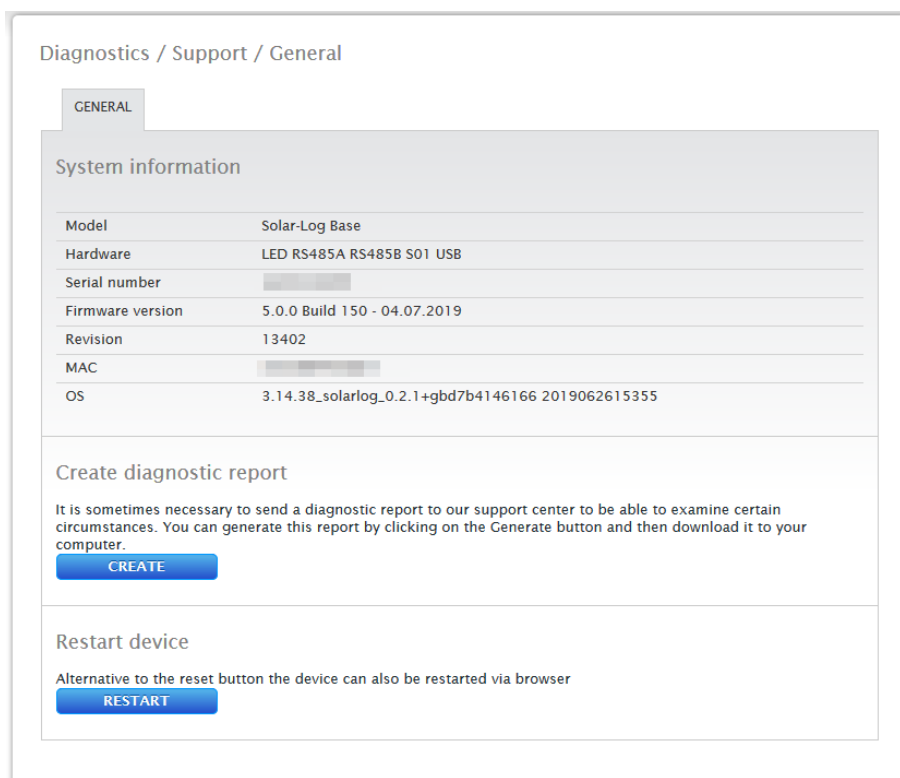

Fig.: Support - General

There are three sections under the Support | General menu:

- System Information:

The following information is available in this tab:

- Model (type of Solar-Log™).
- Hardware (hardware components available for the device).
- Solar-Log™ serial number.
- Firmware Version and date.
- Revision number.
- MAC (MAC address of the device).
- OS (Operating System of the Solar-Log™).

- Creating diagnostic reports:

You have the option to create and download a diagnostic report. This can be sent to Solar-Log support for analysis.

See Figure: Support - General.

- Restart

With the button "Restart", the Solar-Log™ can be restarted via the web menu.

22 Yield Data Menu

Click on Yield Data in the tool bar to access the Yield Data menu.

The following options can be selected from the left-side navigation menu.

- Current values
- Production
- Consumption (only appears when a consumption meter is connected)
- Balances
- Sensor (only appears when a sensor is connected)

22.1 Current values

The **Cockpit** tab can be automatically selected from the **Current values**. The Dashboard view of the plant includes the following values:

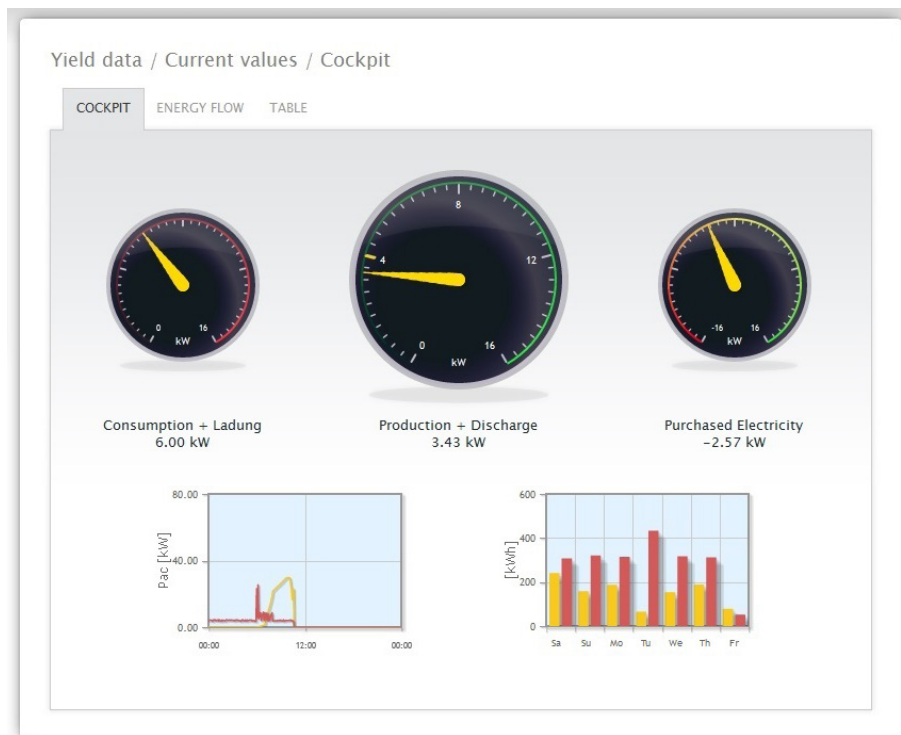

Fig.: The plant's current values (cockpit view)

- Consumption (only when consumption meters are connected). This displays the current consumption.
- Production (power generated by the plant) + Discharge (only if battery storage system is connected), shows the current production and discharge of the battery. The maximum value is indicated in the tachometer by a yellow mark (graduation line).
- Feed-in amount (only when meters are connected). This displays the power output that is currently being fed into the grid.

There are two graphs located below the Dashboard display:

- The current day curve (graph on the left):
There is also the option to display the previous six days as a curve in this graph. Therefore, just click on the day value in the graph on the right.
- The current day value as well as those from the previous 6 days (graph on the right):
Move the mouse above one of the bars to display the day value. Click on one of the bars to have it display in the graph on the left as a curve.

Additional tabs can be selected in this view:

- Energy flow
- Table

Note!



If the Solar-Log™ is just used as a consumption monitoring tool, the menu is limited to **Current values**, **Consumption** and **System information**. All of the other menus are hidden.

Note!



When only consumption meters are connected to the Solar-Log™, a large consumption tachometer is displayed instead of the production tachometer in the **Current values** | **Cockpit** menu.

22.1.1 Energy flow

The plant is displayed as a flow graphic in the Energy flow tab.

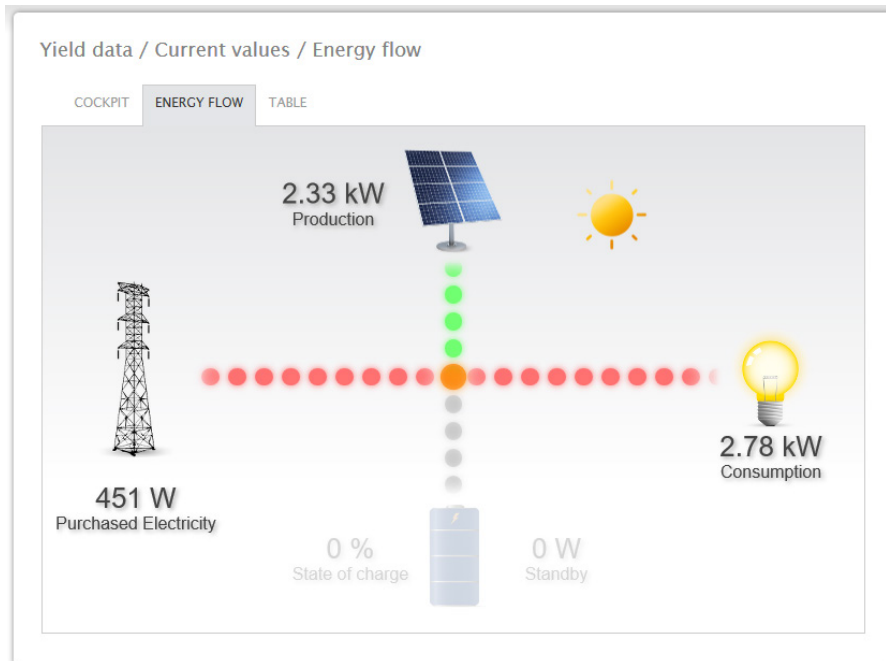

Fig.: Example of a plant with an energy flow

Depending on the particular devices connected, the following values are displayed in the flow graphic in real time:

- Production (W)
- Consumption (W)
- Grid fed / purchase from grid (W)
- Battery Status
 - Charge Status (%)
 - Charge / Discharge Output (W)

Note:

When a battery meter is connected, the value for the battery's charge status cannot be read. That is why for the presentation of energy flows that the charge status is displayed with n/a and the charge with 0 W.

Energy Flow Color Key

- Production (W):
 - Green, energy is being generated.
 - Gray, energy production is not active.
- Consumption (W):
 - Red, energy is being consumed.
 - Grey, no active consumption.
- Grid fed / purchase from grid (W)
 - Red, energy is being purchased from the grid.
 - Green, energy is being fed into the grid.
 - Gray, no energy transfer in either direction with the grid.

Battery:

- Charge Level (%):
 - Red, battery is being charged.
- Discharge (W):
 - Green, battery is being discharged.

22.1.2 Table

The output recorded from the connected devices is displayed as a table in Table tab.

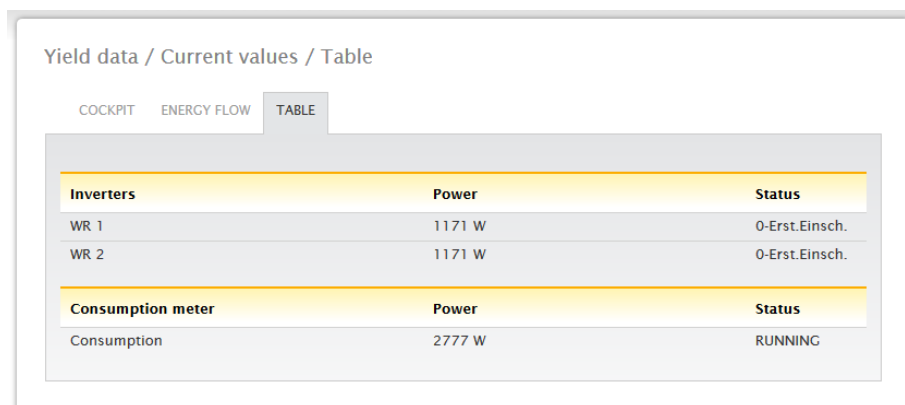

The screenshot shows a web interface with the title 'Yield data / Current values / Table'. At the top, there are three tabs: 'COCKPIT', 'ENERGY FLOW', and 'TABLE', with 'TABLE' being the active tab. Below the tabs is a table with two sections. The first section is titled 'Inverters' and has three columns: 'Inverters', 'Power', and 'Status'. It contains two rows: 'WR 1' with '1171 W' and '0-Erst.Einsch.', and 'WR 2' with '1171 W' and '0-Erst.Einsch.'. The second section is titled 'Consumption meter' and also has three columns: 'Consumption meter', 'Power', and 'Status'. It contains one row: 'Consumption' with '2777 W' and 'RUNNING'.

Inverters	Power	Status
WR 1	1171 W	0-Erst.Einsch.
WR 2	1171 W	0-Erst.Einsch.

Consumption meter	Power	Status
Consumption	2777 W	RUNNING

Fig.: Table with the recorded output from an example plant

Depending on the particular device connected, the following values are displayed:

- The current output from each individual inverter.
- The total current consumption as measured by the consumption meters.
- The current irradiation per m² as measured by the sensor.
- The values from the battery with the columns Charge/Discharge, Charge Level (%) and Status.

22.2 Production

You can select a graphic display of your plant's production from the **Production** menu.



Fig.: Graphic display of the plant's total production

You can select the following tabs from this display:

- Day
- Month
- Year
- Total

You can select to display the view as a **Graph** or **Table**. The actual values displayed in the graph or table depend on the view selected.

Note!



The auto scaling option always scales the graphics up as much as possible. The auto scaling can be manually disabled for the respective graphics. Then the scaling is done based on the value defined in the device configuration. Please refer to the the chapter on configuring inverters in the Installation Manual.

The selected section can be enlarged by clicking on the graphic and dragging it.

22.2.1 Day view

The **Day** tab displays the current day as a curve graph. The values **Output (W)** and **Yield (kWp)**, on the top left of the diagram key, can be selected and deselected at anytime with a left-click to display individual values (curve) or to display or hide all values (curves). With a right-click, all of the values (curves) other than the one selected can be hidden.

The different values throughout the day can be displayed by moving the mouse along the curve.

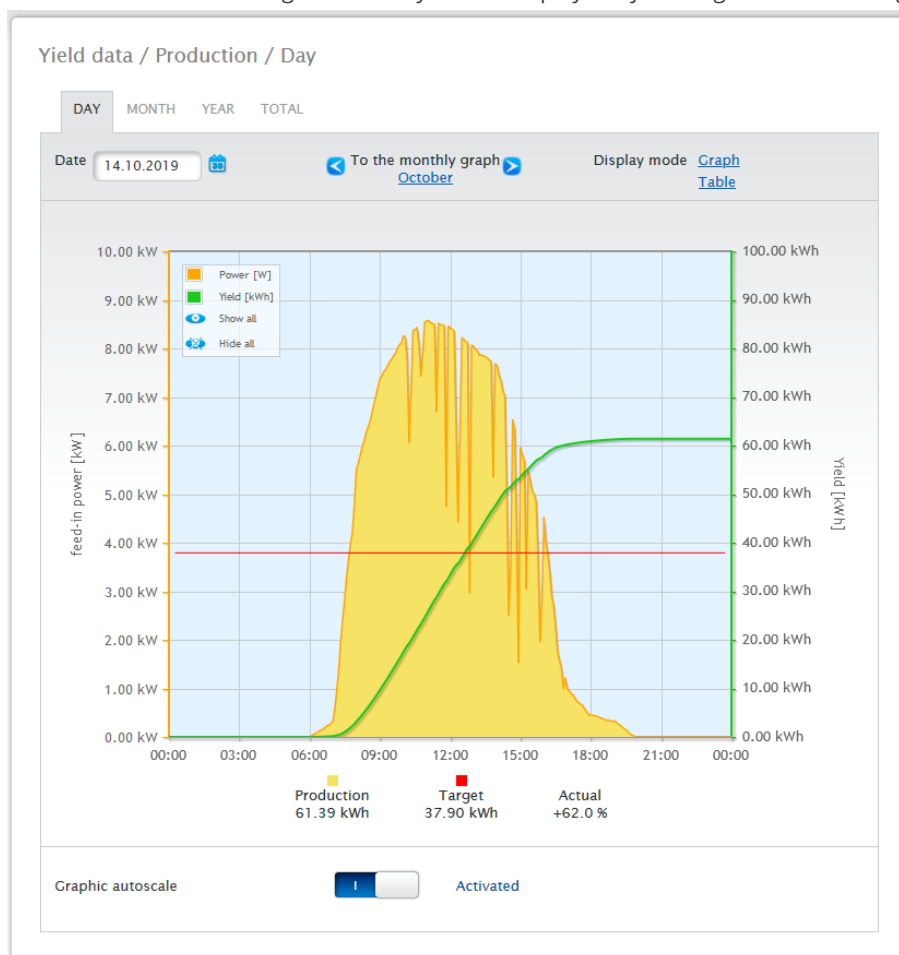

Fig.: Daily View of the Production Graph with the Auto Scaling activated

The following data is graphically displayed in the production day:

- Production (kWh) (If the daily yield value is modified with the data correction function, the modifications are displayed in brackets.)
- Target (kWh).
- Current (%).



Fig.: Daily View of the Production Graph with the Auto Scaling deactivated

Different values with different units are displayed in the graph. The units used and their colors are defined in the key at the top.

Inverter	Name	Yield [kWh]	Specific Yield [kWh/kwp]
3	BHKW-Rel	33.48	2.79
4	Kostal	27.91	2.79
Total		61.39	2.79

Fig.: Day view of the production table

When you click on **Table**, the values from the current output generated will be allocated to the individual inverters and displayed as a table. In this way, you can check the output of every individual inverter at any time.

22.2.2 Month view

The tab **Month** displays the daily yields from the month as a total in a bar graph.

- The daily yield can be displayed by moving the mouse above one of the bars.
- Click on a bar to go to the corresponding day view.



Fig.: Month view production graph

Yield data / Production / Month

DAY MONTH YEAR TOTAL

Date: 10.2019  [To the yearly graph 2019](#) Display mode: [Graph](#) [Table](#)

Date	Yield [kWh]	Specific Yield [kWh/kWp]	set value (cumulative) [kWh]	Actual [%]
01.10.2019	61.69	2.80	37.90	+62.8
02.10.2019	63.55	2.89	37.90	+67.7
03.10.2019	42.37	1.93	37.90	+11.8
04.10.2019	17.41	0.79	37.90	-54.1
05.10.2019	8.24	0.37	37.90	-78.3
06.10.2019	49.79	2.26	37.90	+31.4
07.10.2019	44.21	2.01	37.90	+16.7
08.10.2019	8.53	0.39	37.90	-77.5
09.10.2019	63.50	2.89	37.90	+67.6
10.10.2019	26.04	1.18	37.90	-31.3
11.10.2019	63.14	2.87	37.90	+66.6
12.10.2019	50.27	2.28	37.90	+32.6
13.10.2019	16.87	0.77	37.90	-55.5
14.10.2019	61.39	2.79	37.90	+62.0
15.10.2019	19.63	0.89	37.90	-48.2
16.10.2019	8.17	0.37	37.90	-78.4
17.10.2019	50.61	2.30	37.90	+33.6
18.10.2019	2.60	0.12	37.90	-93.1
19.10.2019	0.00	0.00	37.90	-100.0
20.10.2019	0.00	0.00	37.90	-100.0
21.10.2019	0.00	0.00	37.90	-100.0
22.10.2019	0.00	0.00	37.90	-100.0
23.10.2019	0.00	0.00	37.90	-100.0
24.10.2019	0.00	0.00	37.90	-100.0
25.10.2019	0.00	0.00	0.00	0.0
26.10.2019	0.00	0.00	0.00	0.0
27.10.2019	0.00	0.00	0.00	0.0
28.10.2019	0.00	0.00	0.00	0.0
29.10.2019	0.00	0.00	0.00	0.0
30.10.2019	0.00	0.00	0.00	0.0
31.10.2019	0.00	0.00	0.00	0.0
Total	658.01	29.91	909.52	-27.7

Fig.: Month view of the production table

When you click on [Table](#), the values: date, yield, specific yield and target (cumulative), current and target are listed for the entire month.

22.2.3 Year view

The tab **Year** displays the monthly yields from the year as a total in a bar graph.

- Move the mouse above one of the bars to display the monthly yield with a comparison of the current and target values in regard to the annual forecast.
- Click on a bar to go to the corresponding month view.

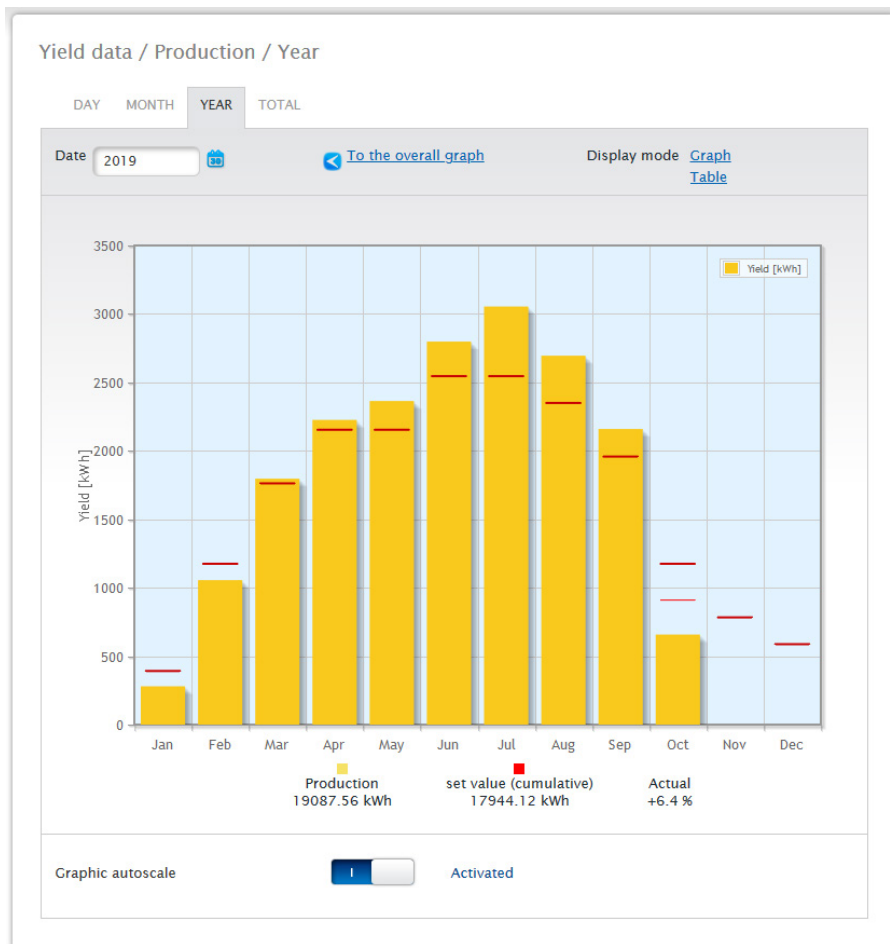

Fig.: Year view graph

When you click on [Table](#), the annual values for the entire year are allocated to each month according to the actual output generated.

22.2.4 Total view

The **Total** tab displays the annual yields as a total in a bar graph. The red line displays the calculated target balance based on the annual forecast.

- Move the mouse above one of the bars to display the annual yield with a comparison of the current and target values in regard to the annual forecast.
- Click on a bar to go to the corresponding year view.



Fig.: Total view graph

Table:

The plant's total power output (since the monitoring started) is allocated every each according to the output generated.

The Date box is included in the day, month and year view and has a calendar function with which you can search for certain days, months or years according to the view selected. You can go backwards and forwards within the selected period with the arrow keys for the previous day or week, or for the following day or week.

22.3 Consumption (only when consumption meters are connected)

Under the menu item [Consumption](#) you can see the total power consumption.

Note!



Consumption is only displayed once a meter is connected.

The day view can be selected from the [Consumption](#) menu. The view appears as a [Day Graph](#) with the total consumption values.

As soon as sub-consumers are connected, e.g. a washing machine or freezer, the view expands to include the tab [Details Sub-consumers](#).

All of the appliances consuming electricity are shown in different colors here and they are also displayed as in a pie chart at the bottom with the colors in the key.

It is also possible to display the Daily Consumption graphic as a line graphic. There is the option to display or hide the consumption from particular appliances in line graphic view.



Fig.: Graph of daily consumption with meters connected

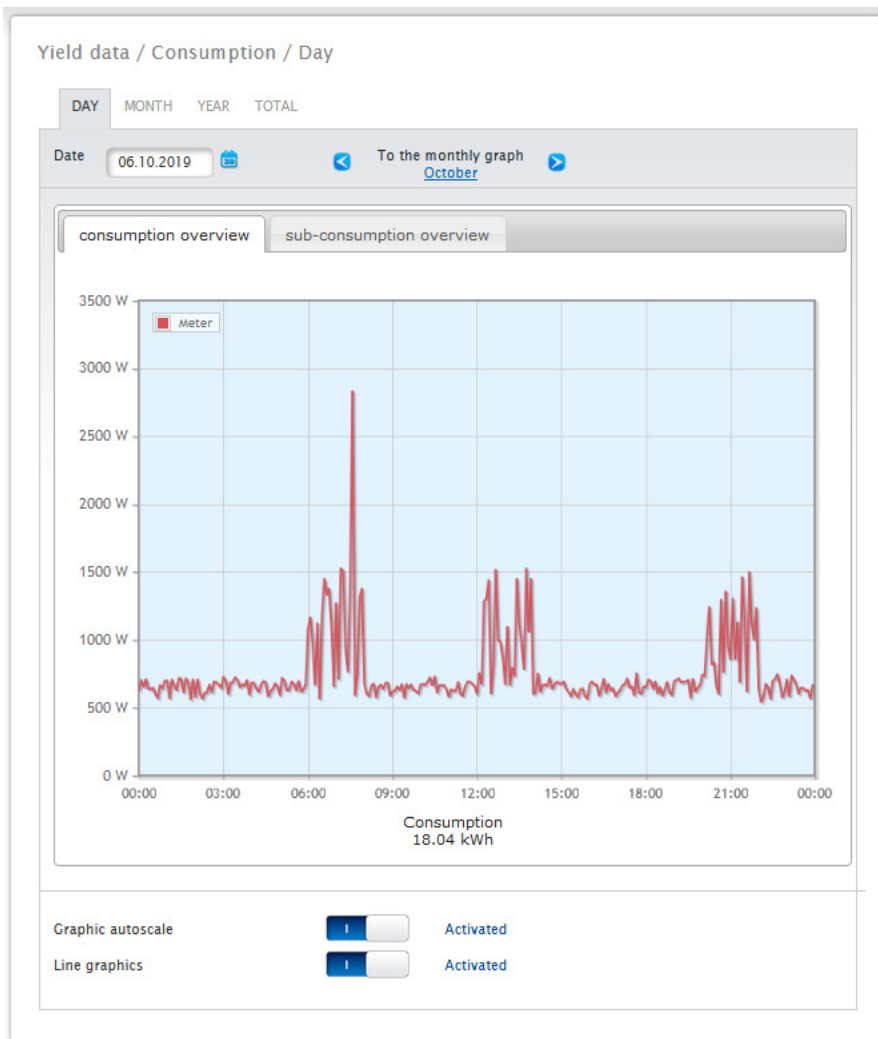

Fig.: Graph of daily consumption with meters connected and active line graphics

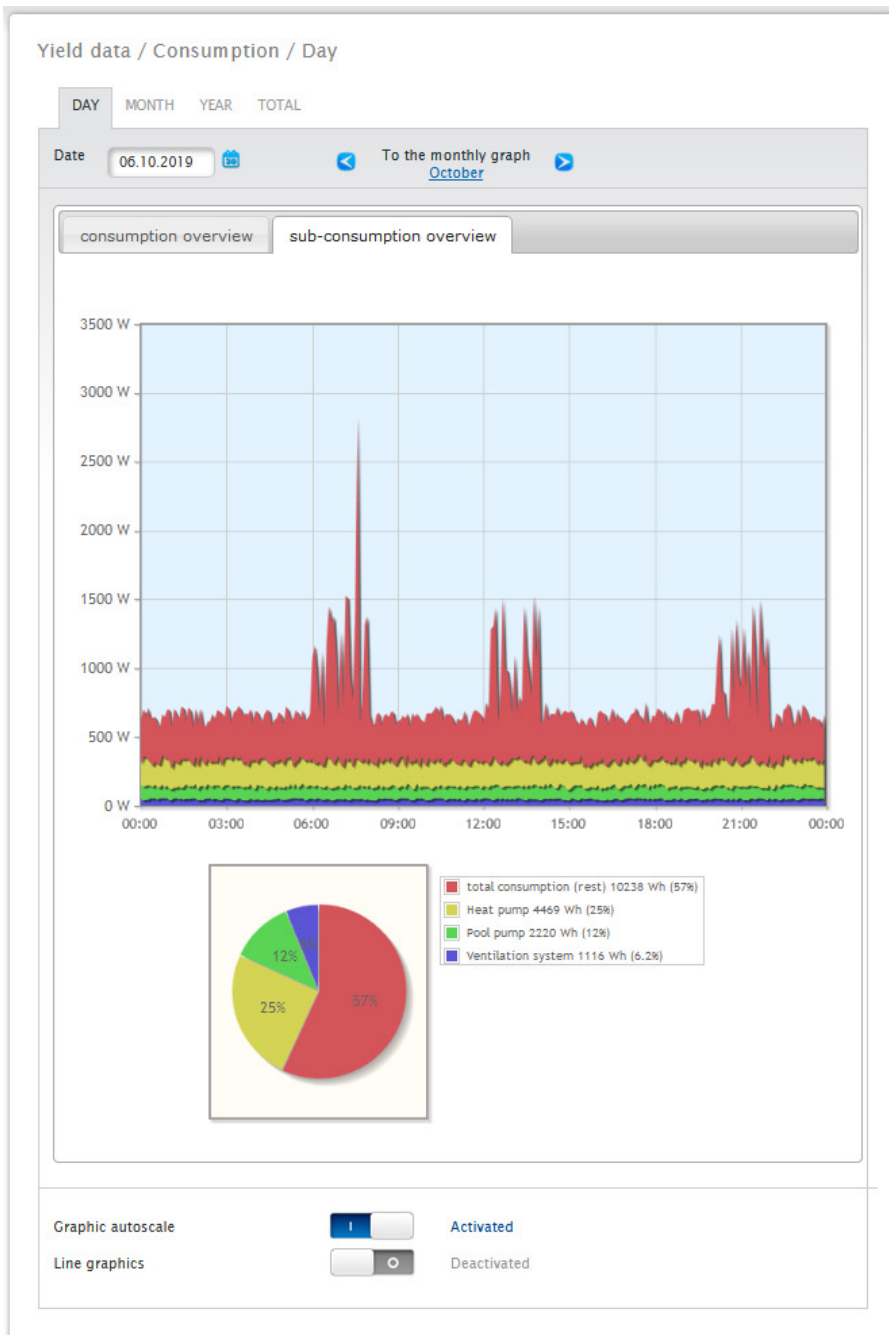

Fig.: Graph of daily consumption with connected appliances in the sub-consumer view

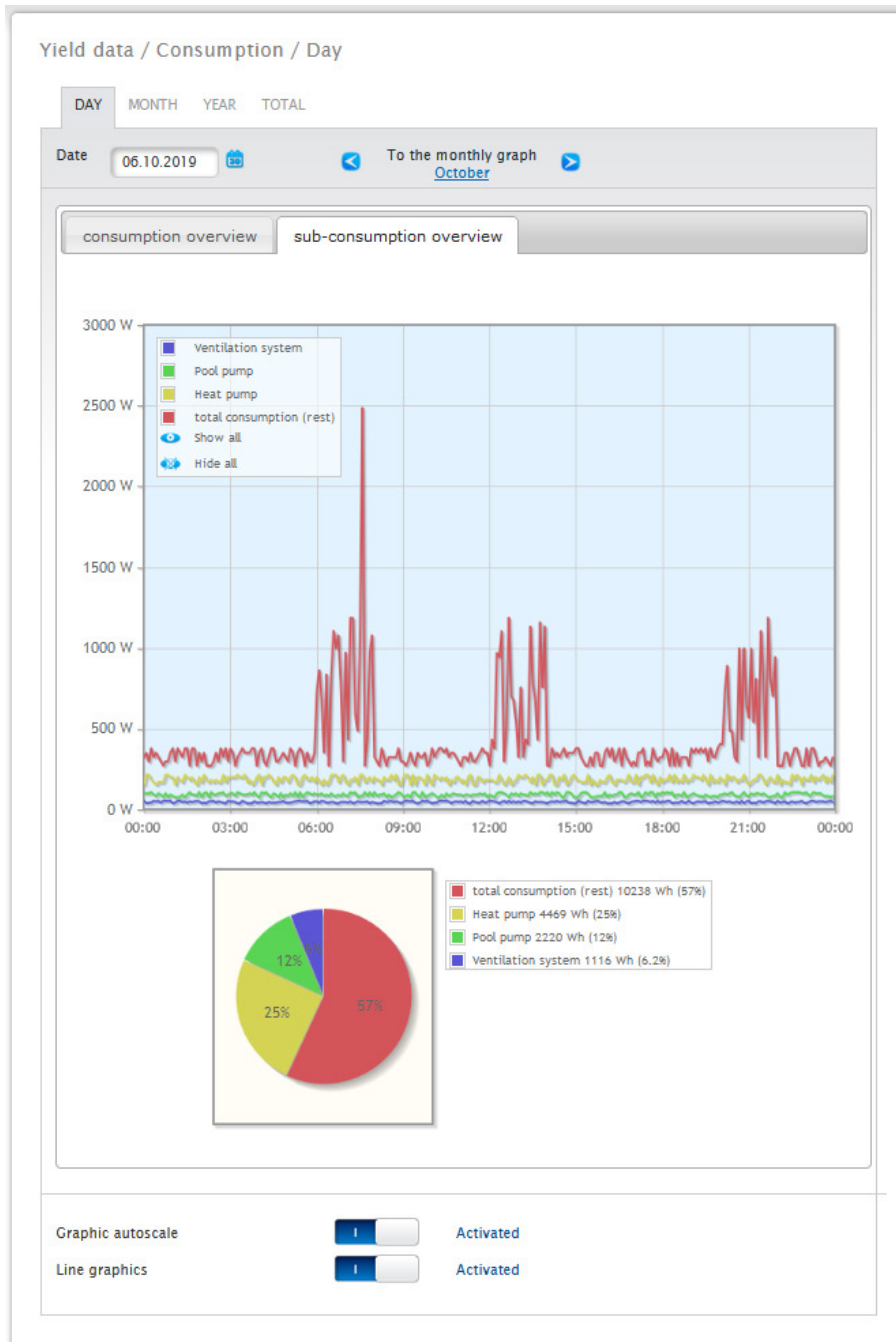

Fig.: Graph of daily consumption with connected appliances and active line graphics in the sub-consumer view

You have the option to select additional menu items in the consumption view.

- **Month:**

displays the Month Graph View as a bar graph. There are two tabs in the Month View, the same as in the Day View: The **Consumption Overview** and the **Sub-consumer Overview**.

The total consumption values are displayed in the Consumption Overview as a bar graph.

In the **Sub-consumer Overview**, you see the devices connected as a bar graph with the power consumption displayed in different colors. Below this, the values are also displayed in a pie chart with the colors in the key.

There is the option from both views to select the days directly from the individual bars and sections.

- **Year:**

displays the Year Graph View as a bar graph. There are two tabs in the Year View, the same as in the Month View: The [Consumption Overview](#) and the [Sub-consumer Overview](#).

The total consumption values are displayed in the Consumption Overview as a bar graph.

In the [Sub-consumer Overview](#), you see the devices connected as a bar graph with the power consumption displayed in different colors. Below this, the values are also displayed in a pie chart with the colors in the key.

There is the option from both views to select the individual months directly from the individual bars and sections.

- **Total:**

displays the Total Graph View as a bar graph. There are two tabs in the Total View, the same as in the Year View: The [Consumption Overview](#) and the [Sub-consumer Overview](#).

The total consumption values are displayed in the Consumption Overview as a bar graph.

In the [Sub-consumer Overview](#), you see the devices connected as a bar graph with the power consumption displayed in different colors. Below this, the values are also displayed in a pie chart with the colors in the key.

There is the option from both views to select the individual years directly from the bars and sections.

22.4 Balances

You can see the relationship between your plant's production and consumption from the **Balances** menu. The following points are displayed in all of the views (day, month, year and total):

- Production
- Consumption
- Self-consumption

The following factors additional displayed when a battery system is connected (see Fig.: Day Balance graph with battery system):

- Self-consumption Battery (kWh)
- Charge (kWh)
- Discharge (kWh)

Note!



The consumption as well as the values from the battery are only displayed once the systems are connected (consumption meter + battery energy storage system).

Note!



The auto scaling option always scales the graphics up as much as possible. The auto scaling can be manually disabled for the respective graphics. Then the scaling is done based on the value defined in the device configuration.

The selected section can be enlarged by clicking on the graphic and dragging it.

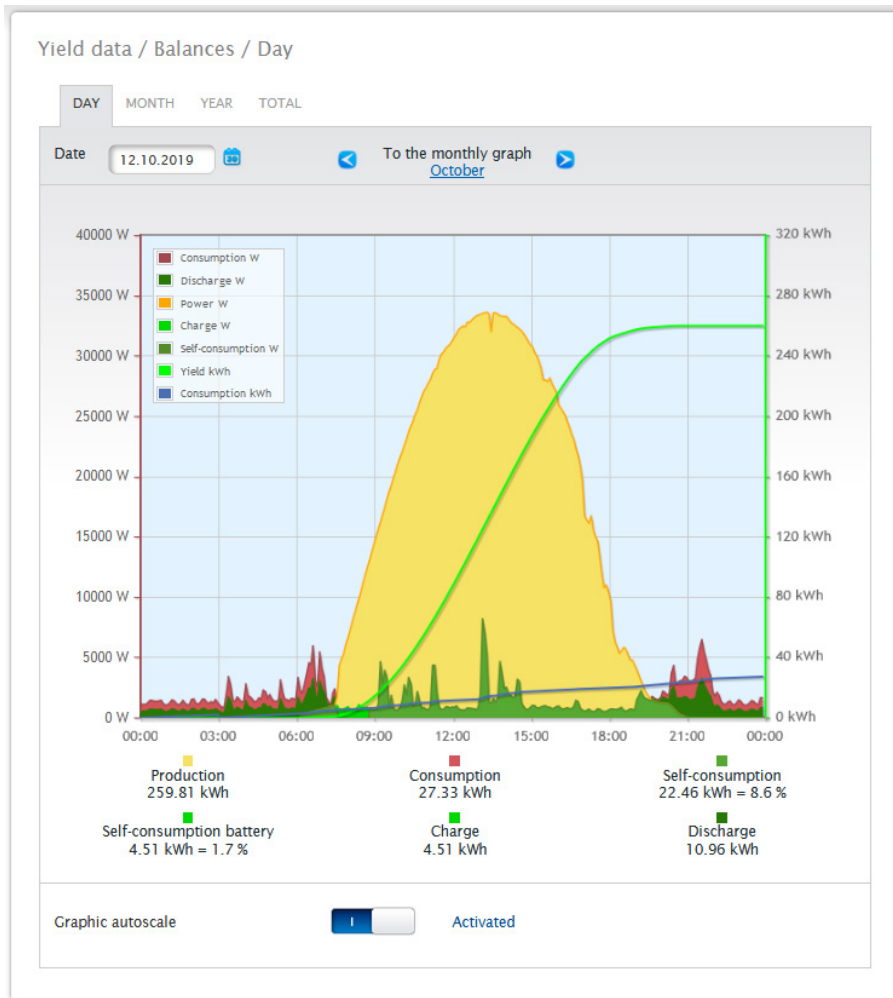

Fig.: Day Balance graph with battery energy storage system

The following tabs can be selected:

- Day
- Month
- Year
- Total

The start view displays the current daily values as a graph.

22.4.1 Day balance

The **Day** tab under Balances displays the production, consumption and self-consumption side-by-side as a day curve. The values in the diagram key, can be selected and deselected at anytime with a left-click to display individual values (curve) or to display or hide all values (curves).

With a right-click, all of the values (curves) other than the one selected can be hidden.

Different values with different units are displayed in the graph. The units used and their colors are defined in the key at the top.

The different values throughout the day can be displayed by moving the mouse along the curve.

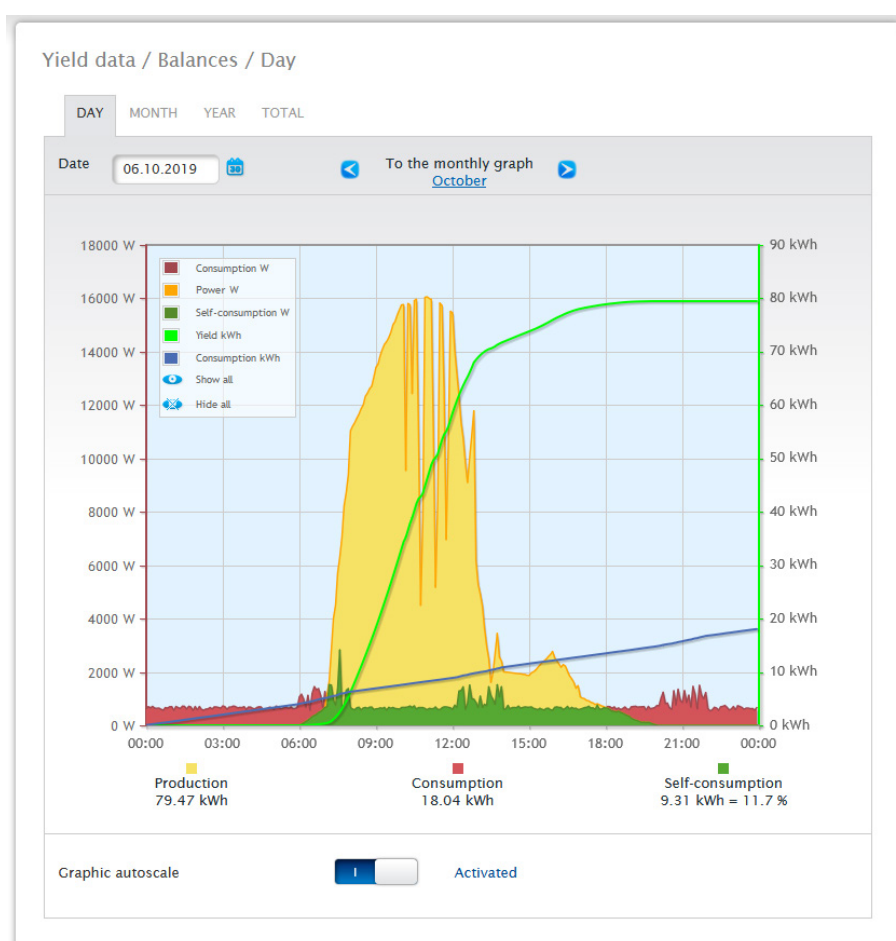

Fig.: Daily Balance Graph with the Auto Scaling activated

The following data is graphically displayed in the daily balance:

- Production (kWh).
- Consumption (kWh) (If the daily consumption value is modified with the data correction function, the modifications are displayed in brackets.)
- Self-consumption.

The meaning of the colored areas in the day curve:

The green areas display the amount of consumption that was covered with PV power. The yellow areas display the surplus of PV-generated power and the red areas display the amount of consumption that was not covered with PV power.

You have a choice between the **Graph** and **Table** display mode.

General definition of the different colored areas within the balance graphs:

(see figure: Daily Balance Graph)

- Yellow areas - Production.
- Red areas - Consumption (Total = not covered by production (red in the graph) + covered by production (green in the graph)).
- Green area - self-consumption (covered by production - green in the graph) with a percentage (in relation to production).

22.4.2 Month balance

The tab **Month** under balances displays the production and consumption side-by-side in a bar graph.

- Move the mouse above one of the bars to view either the daily yield or consumption.
- Click on one of the bars to go to the corresponding day view.



Fig.: Month view balance graph

22.4.3 Year balance

The Year tab under Balances displays the production and consumption side-by-side in a bar graph.

- Move the mouse above one of the bars to view either the monthly yield or consumption with a comparison of the current and target values in regard to the annual forecast.
- Click on one of the bars to go to the corresponding month overview.



Fig.: Year view balance graph

22.4.4 Total balance

The **Total** tab under Balances displays the production and consumption side-by-side in a bar graph.

- Move the mouse above one of the bars to view either the annual yield or consumption with a comparison of the current and target values in regard to the annual forecast.
- Click on one of the bars to go to the corresponding annual overview.

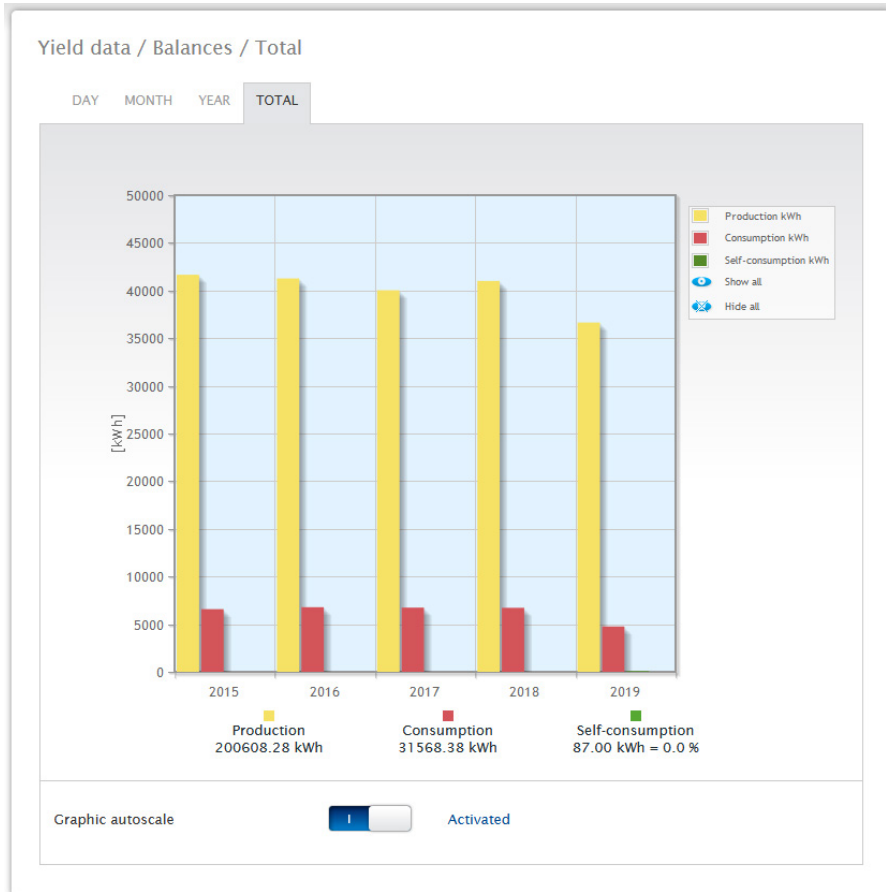

Fig.: Total balance graph

22.5 Sensor (only when connected)

A graphic evaluation from the connected sensors can be displayed from the **Sensor** menu.

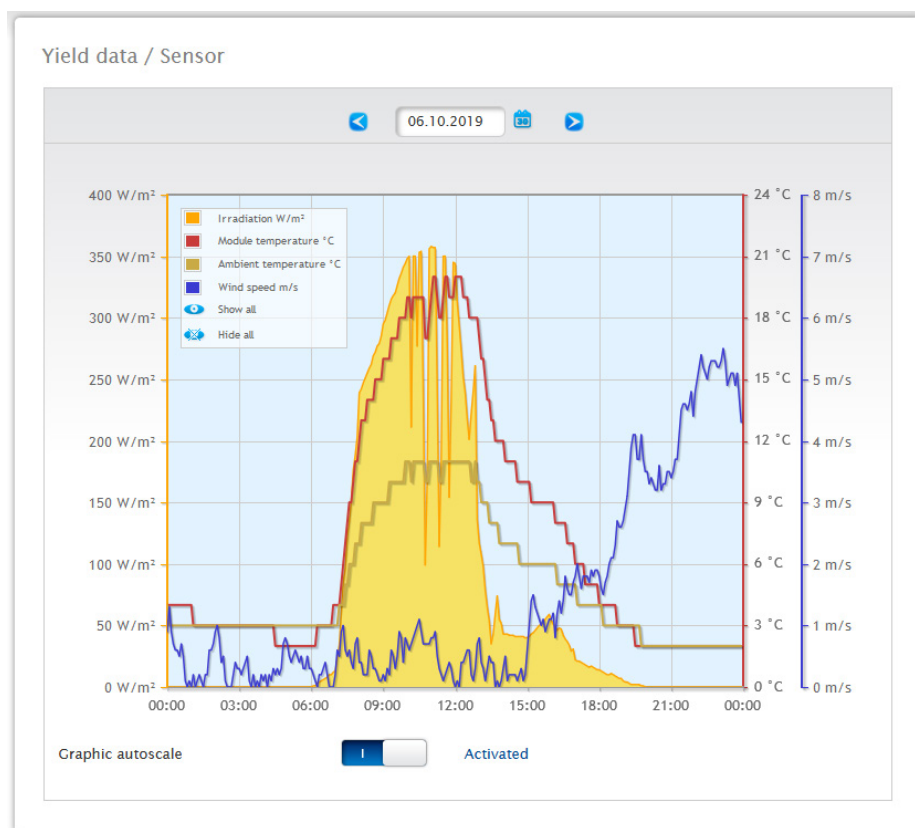

Fig.: Graph of Sensor Box values

The following values can be displayed individually:

- Irradiation W/m².
- Module temperature C°.
- Ambient temperature C°.
- Wind speed m/s.

Different values with different units are displayed in the graph. The units used and their colors are displayed in the key at the top.

All of the values displayed can be selected and deselected at anytime with a left-click to display individual values (curve) or to display or hide all values (curves). With a right-click, all of the values (curves) other than the one selected can be hidden.

You can select and subsequently evaluate certain days with the Date box.

Note!







The menu is only visible once a meter is connected.

23 Display Definition

The following sections can be accessed with the touch function (swiping up, down, to the right or to the left).

- Values
- Status
- Configuration
- Installation
- QR Code

23.1 Generation Display Controls

Controls	Meaning	Further explanation
	Swipe to the right	When the displays spans several pages, tap on the arrow to go to the next page and back to the previous page.
	Swipe to the left	
	Swipe up	
	Swipe down	

23.2 Values

The values are displayed as a cockpit or energy flow graphic. The following values can be displayed in the cockpit graphic:

- Production
- Consumption
- Battery (when connected)
- Feed-in

Values



Cockpit



Energy flow



The Energy Flow graphic displays:

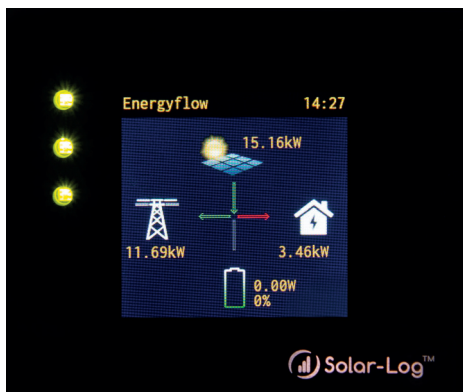

Fig.: Example of a plant with an energy flow

Depending on the particular devices connected, the following values are displayed in the energy flow graphic in real time:

- Production
- Consumption
- Grid Fed / Purchase from Grid
- Battery Status (only when connected)
 - Charge status
 - Charge / Discharge Output

Note:

When the battery is not connected directly, but via a battery meter (bi-directional meter), the battery charge status is not displayed. That is why for the presentation of energy flows that the charge status is displayed with n/a and the charge with 0 W.

Energy Flow Color Key

- Production:
 - Green, energy is being generated.
 - Gray, energy production is not active.
- Consumption:
 - Red, energy is being consumed.
 - Grey, no active consumption.
- Grid fed / purchase from grid:
 - Red, energy is being purchased from the grid.
 - Green, energy is being fed into the grid.
 - Gray, no energy transfer in either direction with the grid.

Battery:

- Charge:
 - Red, battery is being charged.
- Discharge:
 - Green, battery is being discharged.

The values, production, consumption and surplus are displayed in the balance (energy balance).

23.3 Status

Here the detected devices and device status of the individual components (e.g. whether online or offline) are displayed.

Status



Devices

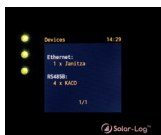

Device Status (1)



Device Status (2)



23.4 Configuration

The network and Internet settings can be viewed in the configuration section. The network settings can also be reset and the factory settings restored.

Configuration



Network Settings (1) Network Settings (2) Network Settings (3)



Internet Settings

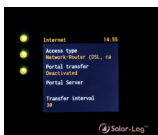

Reset (1) Reset (2)



23.5 Installation

The plant name, the size of the plant as well as the device name and the serial number can be viewed from the "Installation" menu. Missing licenses and their article numbers are also displayed.

Installation



General



Licenses (1)

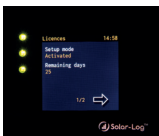

Licenses (2)



23.6 QR Code

QR codes, for example, can be displayed and/or processed via a smartphone.

- Info Center
- Licenses

QR Code



Info Center



Licenses



Note!



A QR code scanner has to be installed on the smartphone in order to read the QR codes.

23.7 Solar-Log Base LEDs

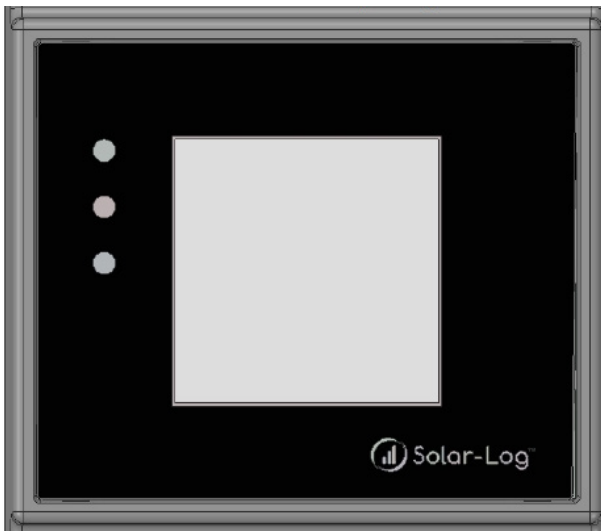

Fig.: Display with LEDs

Depending on the operating state, the LEDs can be lit up continuously in different colors.

Normal operation

Solar-Log Base - LEDs (from top to bottom)

Name	Color	Meaning
Power (top)	is green	Power supply available
Internet (middle)	is red	No Internet connection. ▶ Check the network cables.
Internet (middle)	is orange	DNS failure.
Internet (middle)	is green	Internet connection available
Components (bottom)	is red	Connection lost to at least one component.
Components (bottom)	is green	Normal operation. Connection established to the components. (The LED is also green when there is no solar irradiation, e.g. night shut-off)

24 Faults

24.1 Error messages

24.1.1 Fault messages time

These fault messages are displayed on the virtual LCD display

Fault messages Time

Error code	Message	Possible cause or remedy
		
1	No time/date set	Set the time and date or use the automatic time synchronization function
TM		Just like error 1 The names have been changed with Firmware 3.0.2.

24.1.2 Fault messages Internet

These fault messages are displayed on the VLCD display.
The Internet symbol blinks and the corresponding error code is displayed.

Fault messages Internet

Error code	Possible cause or remedy
	
1	Check the Internet connection and network configuration.
2	The active DNS server configured under Configuration Network Ethernet is not available. Check the configurations.
3	No DNS server available Check the configurations and make sure that the correct DNS server has been entered.
4	The configured DNS server is not available. Please enter the correct DNS server.
5	DNS server could not resolve the server address. Check the DNS server and the server address.

Note!



The globe lights up permanently if the Internet connection is configured correctly. Please ensure that the following ports are enabled for the Solar-Log™:

- HTTP (port 80)
- E-mail (port 25 or 587)
- Ping command (ICMP protocol)

The Solar-Log™ checks the HTTP transmission, e-mail transmission and regularly the PING to the server. If one of these tests is not successful, this is indicated by a flashing globe in the display.

24.1.3 Fault messages Feed-in Management

These fault messages are displayed on the VLCD display.
The percentage symbol blinks and the corresponding error code is displayed.

Fault messages Feed-in Management

Error code	Possible cause/remedy
1	Undefined status for the PM interface or an invalid channel setting for the active and reactive power management. => Check the wiring and configuration.
2	Communication error with the I/O Box => Check the wiring and the power supply for the I/O Box. => Check the interface selected under Configuration Feed-in Management Profile.

24.1.4 Portal Transfer Fault messages

Portal Transfer Fault messages

Error code	Message	Possible cause/remedy
101	The server address could not be resolved.	The access type was not configured. An alternative DNS server is required. The wrong server was entered. The network connection was disconnected and could not be reestablished.
102	Cannot open socket.	Possible causes: Unknown. If this error continues to occur, contact our technical support.
103	Cannot connect to the socket.	Possible causes: The connection is blocked by a firewall or a router. The wrong server was entered. The server is offline.
220	Authentication failure (portal)	The portal registration was done incorrectly. The portal was not configured for HTTP transfers. The wrong server was entered.
Other	General errors	There is detailed description of this error. If this error continues to occur, contact our technical support.

25 Cleaning and care

25.1 Cleaning tips

Important!



Disconnect the device from the power supply before cleaning it!

- Clean the device on the outside only with a dry, lint-free cloth.
- If the device is very dirty, it can be cleaned with a slightly damp cloth and a commercially available household cleaner.

Important!



When cleaning, make sure that no moisture gets into the device!

25.2 Care tips

- Make sure that the device is not exposed to any moisture or heat, as well as strong sunlight at the location where it is kept.

26 Disposal

Caution



Solar-Log™ contains electronic components that can release highly toxic substances if burned or disposed of along with domestic waste.

The Solar-Log™ can either be disposed of at a recycling center (electrical waste) or returned to the manufacturer Solar-Log GmbH.

Solar-Log GmbH
Fuhrmannstraße 9
72351 Geislingen-Binsdorf
Germany

27 Appendix

27.1 Internet ports

If the Solar-Log™ is connected to the Internet via a router, you must ensure that the following ports on the router have been unblocked for the Solar-Log™:

Function	Protocol	Port (outgoing)	Server used	Notes
Name resolution	DNS	53	According to the network configuration or 8.8.8.8 (Google Public DNS) when the name cannot be resolved with the dedicated DNS.	Normally, only the name server from the local network is used.
Time synchronization	NTP	123	0.pool.ntp.org to 3.pool.ntp.org ntp1-1.cs.tu-berlin.de bonehed.lcs.mit.edu navobs1.gatech.edu 130.149.17.8 130,207,244,240	This function ensures that the correct time is always in the logs. The Solar-Log™ has an internal clock, but it loses the time during a long power outage.
Easy Installation (WEB)	HTTP	80	pool0.solarlog-web.com to pool9.solarlog-web.com	A ping test is performed by the Easy Installation to test the Internet connection and if the DNS server functions.
	ICMP	-	solar-log.com	
FTP Export	FTP	21	According to the configuration.	Since it is a passive FTP connection, additional ports (high port > 1023) are required depending on the FTP server used.
FTP Backup	FTP	21	According to the configuration.	Since it is a passive FTP connection, additional ports (high port > 1023) are required depending on the FTP server used.
FTPS Export	FTP with SSL	21	According to the configuration.	
HTTP Export	HTTP	80	According to the configuration.	
Sending E-mails	SMTP	25 or 465 or 587	According to the configuration.	Depending on which SMTP server is used, other ports could also be required.
Firmware update	HTTP	80	pool0.solarlog-web.com to pool9.solarlog-web.com	
Licenses update	HTTP	80	pool0.solarlog-web.com to pool9.solarlog-web.com	
Direct marketer communication	TCP	443	de-fra.gw.openvpn.com	Incoming and outgoing port protocol.
Modbus query	TCP/IP	502	Solar-Log™ IP address	Access to internal data of Solar-Log™, using external systems and licenses.
Direct marketer communication	VPN	1194	de-fra.gw.openvpn.com	Incoming and outgoing port protocol.
Direct marketer communication	TCP	8883	iot-digitalaccelerator.azure-devices.net	Only for DV with Solar-Log Base via interconnector. Incoming and outgoing port protocol.

27.2 Connection examples for ripple control receivers

Grid operators have not agreed on a universal standard for ripple control receiver signals. As result, there are several variations with the respective wiring and configuration in the Solar-Log™ firmware.

All of the examples refer to active power reduction. When ripple control receivers are used for reactive power, they are configured in the same way.

Note!



The following connection examples are requirements from different grid operators. The labels for the relays in the wiring diagram and in the Solar-Log™'s configuration matrix can differ.

Warning!



Please note the specifications for the load of the ripple control receiver's relays. In certain circumstances, the relays have to be connected to intermediate relays. In any case, the inputs D_IN_X have to be supplied with the control voltage (5V DC) from the Solar-Log™ (PM+ interface Pin 1 and 6).

Warning!



When connecting two ripple control receivers: If the ripple control receiver uses binary signal coding, signal feedback via the ripple control receiver for the reactive power must be prevented by fitting diodes.

Warning!



Emergency stop commands may not be processed via the Solar-Log™. These commands have to function directly with the corresponding protection equipment such as grid and plant protection, section switches and Q/U protection.

27.2.1 Variation with 4 relays (ENBW >100kWp)

Specifications

Ripple control receiver signals

Level	K1	K2	K3	K4	Power output
1	On	Off	Off	Off	100%
2	Off	On	Off	Off	60%
3	Off	Off	On	Off	30%
4	Off	Off	Off	On	0%

Wiring

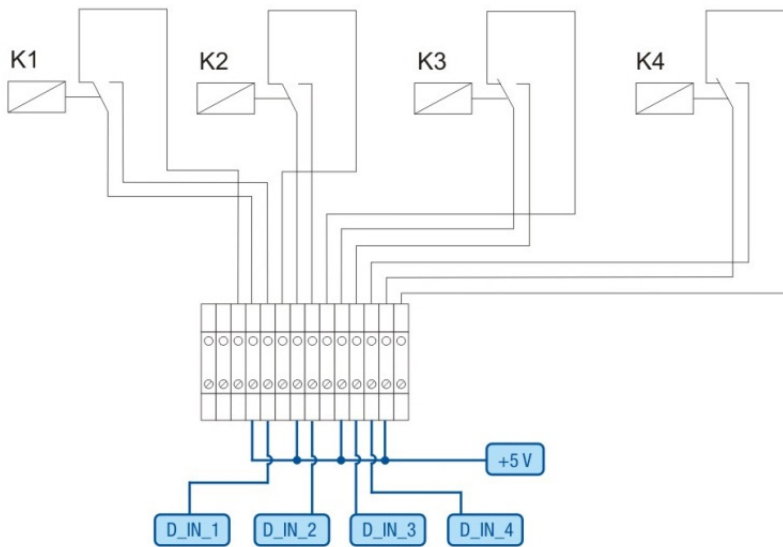

Fig.: Wiring a ripple control receive with two relays - example 1

Connecting PM+ terminal connector and ripple control receiver

PIN	Assignment	Meaning
1	+5V	Control voltage for active power
2	D_IN_1	Level 1 100%
3	D_In_2	Level 2 60%
4	D_In_3	Level 3 30%
5	D_In_4	Level 4 0%
6	+5V	Control voltage for reactive power (unused)

Configuration in browser menu

Remote controlled active power reduction [Configuration](#) | [Feed-in Management](#) | [Active Power](#)

Channel settings for power reduction

Digital input	D_IN_1	D_IN_2	D_IN_3	D_IN_4	Power in %
Level 1	<input checked="" type="checkbox"/>	<input type="checkbox"/>	<input type="checkbox"/>	<input type="checkbox"/>	100
Level 2	<input type="checkbox"/>	<input checked="" type="checkbox"/>	<input type="checkbox"/>	<input type="checkbox"/>	60
Level 3	<input type="checkbox"/>	<input type="checkbox"/>	<input checked="" type="checkbox"/>	<input type="checkbox"/>	30
Level 4	<input type="checkbox"/>	<input type="checkbox"/>	<input type="checkbox"/>	<input checked="" type="checkbox"/>	0

+

Fig.: Channel settings for active power reduction - example 1

27.2.2 Variation with two relays

Specifications

Ripple control receiver signals

Level	K5	K6	Power output
1	Off	Off	100%
2	On	Off	60%
3	Off	On	30%
4	On	On	0%

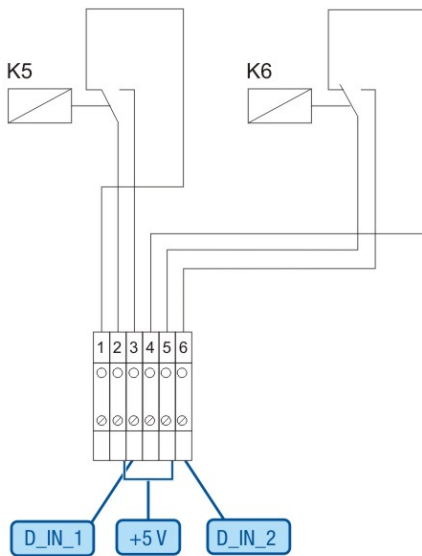

Fig.: Wiring a ripple control receive with two relays - example 2

Connecting PM+ terminal connector
and ripple control receiver

PIN	Assignment	Meaning
1	+5V	Control voltage for active power
2	D_IN_1	K5 switched
3	D_In_2	K6 switched
6	+5V	Control voltage for reactive power (unused)

Configuration in browser menu

Remote controlled active power reduction [Configuration](#) | [Feed-in Management](#) | [Active Power](#)

Channel settings for power reduction

Digital input	D_IN_1	D_IN_2	D_IN_3	D_IN_4	Power in %
Level 1	<input type="checkbox"/>	<input type="checkbox"/>	<input type="checkbox"/>	<input type="checkbox"/>	100
Level 2	<input checked="" type="checkbox"/>	<input type="checkbox"/>	<input type="checkbox"/>	<input type="checkbox"/>	60
Level 3	<input type="checkbox"/>	<input checked="" type="checkbox"/>	<input type="checkbox"/>	<input type="checkbox"/>	30
Level 4	<input checked="" type="checkbox"/>	<input checked="" type="checkbox"/>	<input type="checkbox"/>	<input type="checkbox"/>	0

Fig.: Channel settings for active power reduction - example 2

27.2.3 Variation with three relays

Specifications

Ripple control receiver signals

Level	K2	K3	K4	Power output
1	Off	Off	Off	100%
2	On	Off	Off	60%
3	Off	On	Off	30%
4	Off	Off	On	0%

Wiring

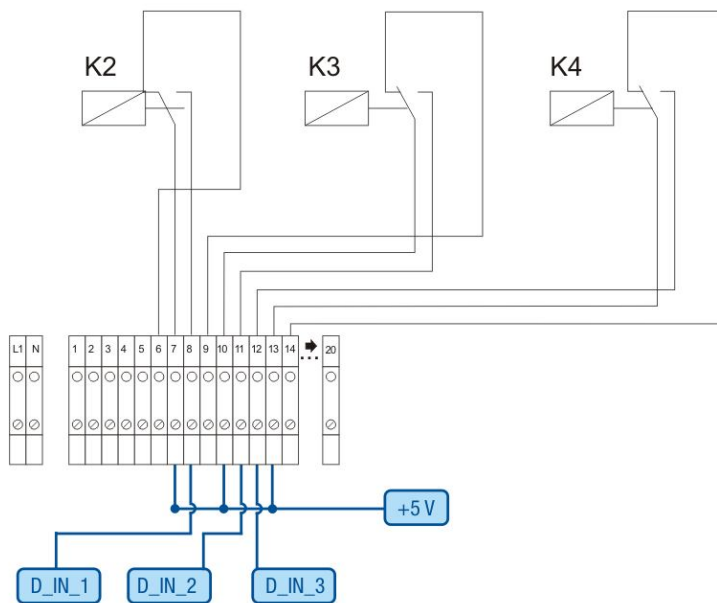

Fig.: Wiring a ripple control receive with two relays - example 3

Connecting PM+ terminal connector and ripple control receiver

PIN	Assignment	Meaning
1	+5V	Control voltage for active power
2	D_IN_1	Level 2 60%
3	D_In_2	Level 3 30%
4	D_In_3	Level 4 0%
5	D_In_4	unused
6	+5V	Control voltage for reactive power (unused)

Configuration in browser menu

Remote controlled active power reduction [Configuration](#) | [Feed-in Management](#) | [Active Power](#)

Channel settings for power reduction

Digital input	D_IN_1	D_IN_2	D_IN_3	D_IN_4	Power in %
Level 1	<input type="checkbox"/>	<input type="checkbox"/>	<input type="checkbox"/>	<input type="checkbox"/>	100
Level 2	<input checked="" type="checkbox"/>	<input type="checkbox"/>	<input type="checkbox"/>	<input type="checkbox"/>	60
Level 3	<input type="checkbox"/>	<input checked="" type="checkbox"/>	<input type="checkbox"/>	<input type="checkbox"/>	30
Level 4	<input type="checkbox"/>	<input type="checkbox"/>	<input checked="" type="checkbox"/>	<input type="checkbox"/>	0

+

Fig.: Channel settings for active power reduction - example 3

27.2.4 Variation with 5 relays (including emergency stop)

Specifications

Ripple control receiver signals

Level	K1	K2	K3	K4	K5	Power output
1	On	Off	Off	Off	Off	100%
2	Off	On	Off	Off	Off	60%
3	Off	Off	On	Off	Off	30%
4	Off	Off	Off	On	Off	0%
5					On	Emergency stop

The relay is continuously activated for a particular level (condition). There is always only one relay that is activated.

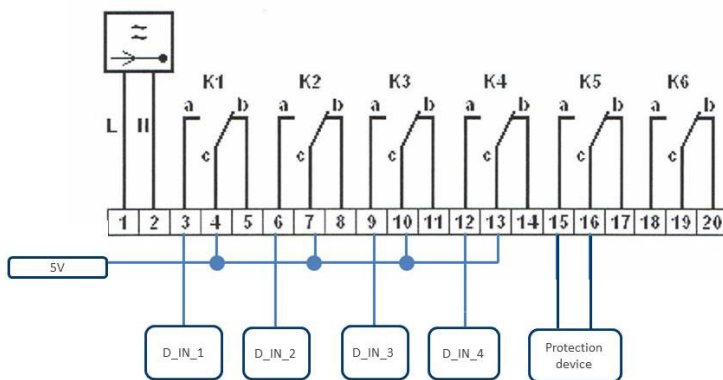

Fig.: Wiring a ripple control receive with two relays - example 4

Warning!



Emergency stop commands may not be processed via the Solar-Log™. These commands have to function directly with the corresponding protection equipment such as grid and plant protection, section switches and Q/U protection.

Connecting PM+ terminal connector and ripple control receiver

PIN	Assignment	Meaning
1	+5V	Control voltage for active power
2	D_IN_1	Level 1 100%
3	D_In_2	Level 2 60%
4	D_In_3	Level 3 30%
5	D_In_4	Level 4 0%
6	+5V	Control voltage for reactive power (unused)

Configuration in browser menu

Remote controlled active power reduction [Configuration](#) | [Feed-in Management](#) | [Active Power](#)

Channel settings for power reduction

Digital input	D_IN_1	D_IN_2	D_IN_3	D_IN_4	Power in %
Level 1	<input checked="" type="checkbox"/>	<input type="checkbox"/>	<input type="checkbox"/>	<input type="checkbox"/>	100
Level 2	<input type="checkbox"/>	<input checked="" type="checkbox"/>	<input type="checkbox"/>	<input type="checkbox"/>	60
Level 3	<input type="checkbox"/>	<input type="checkbox"/>	<input checked="" type="checkbox"/>	<input type="checkbox"/>	30
Level 4	<input type="checkbox"/>	<input type="checkbox"/>	<input type="checkbox"/>	<input checked="" type="checkbox"/>	0

Fig.: Channel settings for active power reduction - example 4

27.3 Digital Interfaces

Solar-Log™ provides two interfaces for exporting the current data. The data is updated every 15-60 seconds.

Warning!



The following descriptions for two interfaces are intended for users with a technical background. Solar-Log GmbH provides these interfaces without any guarantee and with the exclusion of any legal liability.

We do not offer any telephone support for these two interfaces.

27.3.1 Modbus TCP

The intention of this interface is to give easy access to the Solar-Log™ internal data for external SCADA like systems. The interface is designed to read out live data of the attached PV-system.

The interface is not designed to configure the Solar-Log™ or the attached devices. All configuration must be done via the standard Solar-Log™ Web access either local or remote.

ModbusTCP port:

- 502

Slave ID:

- 1

Implemented Modbus functions:

- 04 to read one or multiple 16 bit words
- 06 to write one 16 bit word
- 16 to write multiple 16 bit words

The Solar-Log™ Modbus implementation uses different byte and word orders. The Modbus protocol byte order follows the big-endian Modbus specification and is thus compatible with standard Modbus implementations. Therefore, the higher byte in value is transferred first.

The proprietary-specific register order for 32-bit values uses a little-endian word order. For a 32-bit value, the lower value word is stored in the first register and the higher value word in the second register.

Live data compact – summarized (complete plant)

Live data “compact” summarized is mapped from register 3500-3999.

Data	Unit	Value-Range	Adress	Number Reg.	Func Code	Since Firmware	Description
lastUpdateTime	Sec	32bit unsigned	3500	2	04		Unixtime when last register update has happened. 0=no live data yet
Pac	W	32bit unsigned	3502	2	04		Total Pac of all inverters and inv-type meters
Pdc	W	32bit unsigned	3504	2	04		Total Pdc of all inverters
Uac	V	16bit unsigned	3506	1	04		Average Uac of all inverters
Udc	V	16bit unsigned	3507	1	04		Average Udc of all inverters
Daily yield	Wh	32bit unsigned	3508	2	04		Summarized daily yield of all inverters
Yesterday yield	Wh	32bit unsigned	3510	2	04		Summarized daily yield of all inverters
Monthly yield	Wh	32bit unsigned	3512	2	04		Summarized monthly yield of all inverters
Yearly yield	Wh	32bit unsigned	3514	2	04		Summarized Yearly yield of all inverters
Total yield	Wh	32bit unsigned	3516	2	04		Summarized Total yield of all inverters
Pac consumption	W	32bit unsigned	3518	2	04		Total Pac of all consumption meters
Daily yield cons.	Wh	32bit unsigned	3520	2	04		Summarized daily yield of all consumption meters
Yesterday yield cons.	Wh	32bit unsigned	3522	2	04		Summarized daily yield (yesterday) of all consumption meters
Monthly yield cons.	Wh	32bit unsigned	3524	2	04		Summarized monthly yield of all consumption meters
Yearly yield cons.	Wh	32bit unsigned	3526	2	04		Summarized Yearly yield of all consumption meters
Total yield cons.	Wh	32bit unsigned	3528	2	04		Summarized Total yield of all consumption meters
TotalPower	Wh/Wp	32bit unsigned	3530	2	04		Total installed generator power

27.3.2 Open JSON Interfaces

The JavaScript Object Notation (JSON) is a compact data format to transmit data between applications. The objects documented here can be used in connection with other programs.

The open JSON interface can be activated and deactivated from the [Configuration | System | Access control](#) menu. When activating the interface, a red warning triangle with security information and risks is displayed.

Note



The open JSON interface is deactivated. To activate the open JSON interface, a user password must first be set.

The current data can be accessed via HTTP protocol. To do this an HTTP Post Inquiry needs to be sent to the Solar-Log™. The object requested has to be in the body:

```
POST /getjp HTTP/1.1
Host: solar-log-xxxx
...
Content Length: 20
Connection: keep-alive
Pragma: no-cache
Cache Control: no-cache

{,"801":{,"170":null}}
```

The reply contains a JSON object as a character string in the body:

```
HTTP/1.1 200 OK
Date: Fri, 25 Oct 2019 10:42:32 GMT
Server: IPC@CHIP
Content-Type: text/plain
Transfer-Encoding: chunked

{,"801":{,"170":{,"100": "25.10.19 10:42:15","101":0,"102":0,"103":0,"104":0,"105":0,"106":0,"107":3527647,"108":0,"109":0,"110":0,"111":0,"112":0,"113":1132434,"114":0,"115":0,"116":45000}}}
```

The JSON character string needs to be converted to an object first before it can be data can be processed in a Java script. For example, when the JSON character string contains the variable "tdata" the conversation looks like this:

```
var LiveDaten=JSON.parse(tdata)[801][170];
```

After that the individual data fields can be accessed via the indexes specified in the following table. For example, the current P_{AC} output is displayed as follows:

```
alert(„The current AC output is: „ + LiveDaten[101] + „ W“);
```

JSON Objects

Data point	Value range	Unit	Index	Description
lastUpdateTime	DWORD	Time in the format dd.mm.yy; hh.minmin, secsec	100	Time
Pac	DWORD	W	101	Total output PAC from all of the inverters and meters in inverter mode
Pdc	DWORD	W	102	Total output PAC from all of the inverters
Uac	WORD	V	103	Average voltage UAC from the inverter
DC voltage:	WORD	V	104	Average voltage UDC from the inverter
yieldDay	DWORD	Wh	105	Total yield for the day from all of the inverters
yieldYesterday	DWORD	Wh	106	Total yield for the previous day from all of the inverters
yieldMonth	DWORD	Wh	107	Total yield for the month from all of the inverters
yieldYear	DWORD	Wh	108	Total yield for the year from all of the inverters
yieldTotal	DWORD	Wh	109	Total yield from all of the inverters
consPac	DWORD	W	110	Current total consumption PAC from all of the consumption meters
consYieldDay	DWORD	Wh	111	Total consumption from all of the consumption meters
consYieldYesterday	DWORD	Wh	112	Total consumption for the previous day; all of the consumption meters
consYieldMonth	DWORD	Wh	113	Total consumption for the month; all of the consumption meters
consYieldYear	DWORD	Wh	114	Total consumption for the year; all of the consumption meters
consYieldTotal	DWORD	Wh	115	Accumulated total consumption, all Consumption meter
totalPower	DWORD	Wp	116	Installed generator power

28 Dimensions

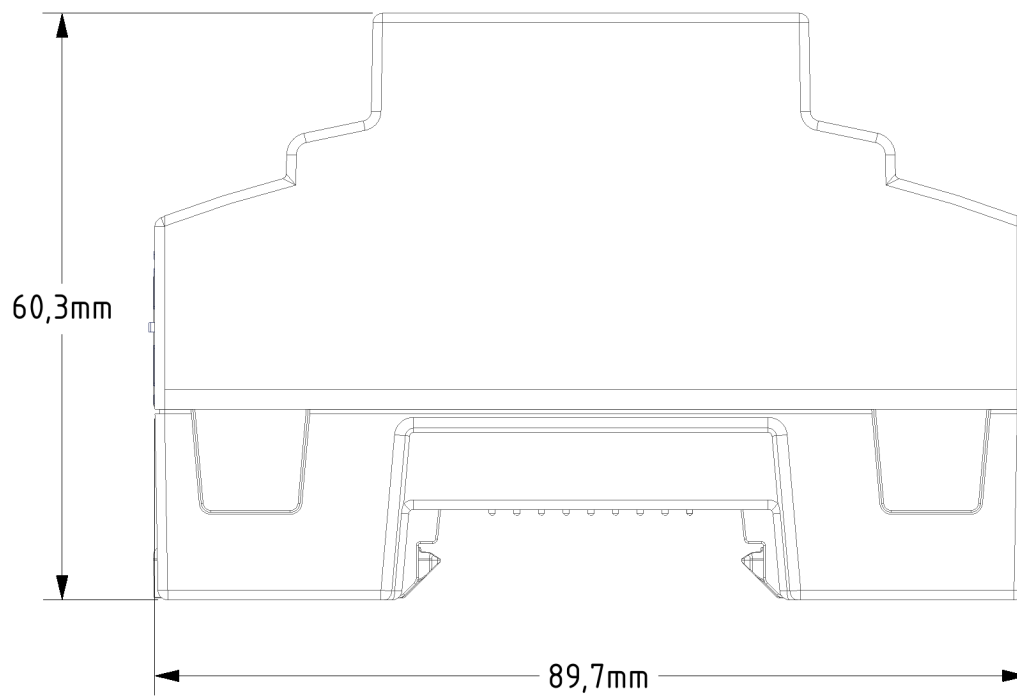
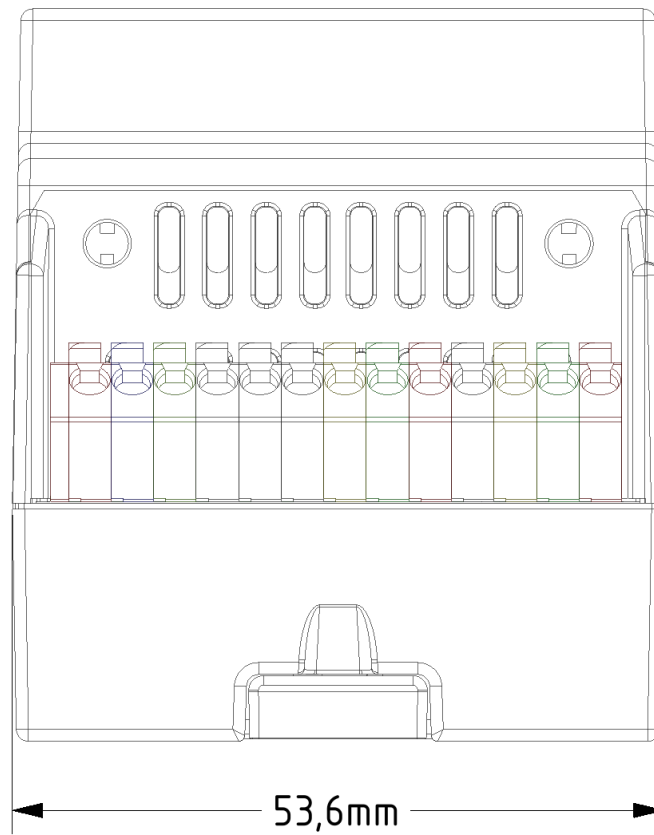

29 List of Figures

Fig.: Solar-Log Base without extended snap-fit tabs	Fig.: Solar-Log Base with extended snap-fit tabs	14
Fig.: Solar-Log Base connections - 2 x RS485 (A and B) or 1 x RS422 - colored PIN connection on the device		15
Fig.: Bottom Connections Solar-Log Base		17
Fig.: Solar-Log Base / Solar-Log MOD I/O with a bus connector joined together.		20
Fig.: Solar-Log Base / Solar-Log MOD I/O without a bus connector		20
Fig.: Solar-Log Base / Solar-Log MOD I/O with a bus connector		20
Fig.: Display of the Solar-Log MOD I/O with LEDs		21
Fig.: Solar-Log Base / Solar-Log MOD 485 with a bus connector joined together.		23
Fig.: Solar-Log Base / Solar-Log MOD 485 without a bus connector		23
Fig.: Solar-Log Base / Solar-Log MOD 485 with a bus connector		23
Fig.: Solar-Log MOD 485 connections - 2 x RS485 (A and B) or 1 x RS422		24
Fig.: Solar-Log MOD 485 connections - bottom side		26
Fig.: Combination Solar-Log Base with Solar-Log MOD I/O and Solar-Log MOD 485 (Connected - front side)		27
Fig.: Combination Solar-Log Base with Solar-Log MOD I/O and Solar-Log MOD 485 (Connected - back side)		27
Fig.: Main menu of the Solar-Log Base 2000		35
Fig.: Pop-up window with security information		36
Fig.: Configuration page "Access control"		37
Fig.: Structure of the Solar-Log Base's Main Menu		38
Fig.: Control elements		39
Fig.: Log in button with selection box		41
Fig.: System Info with example plant		42
Fig.: Header bar with the "Hide Arrow"		43
Fig.: Signal for new firmware		43
Fig.: Automatic Firmware Update Check with notification text displayed		44
Fig.: Info symbol with activate Installation mode		45
Fig.: Red triangle with information text		45
Fig.: "Licenses" menu with the "Required Licenses" section (example)		46
Fig.: Login symbol with selected assistant		47
Fig.: Startup screen of the Solar-Log™ configuration wizard		47
Fig.: Solar-Log™ Ethernet settings from the Solar-Log™ Configuration Wizard		48
Fig.: Example of a successful connection test		50
Fig.: Example of an unsuccessful connection test		50
Fig.: Displayed Firmware Update Window		51
Fig.: Configuration wizard - Example - Interface Assignments		51
Fig.: Example - Configuration Wizard - Device Configuration		52
Fig.: Example - Configuration Wizard Summary		53
Fig.: VLCD Display		55
Fig.: Virtual LCD Display - Meaning of the symbols		56
Fig.: Example for a blinking code sequence for Internet - Fault 4		57
Fig.: Ethernet settings for the first Ethernet interface		59
Example with activated Ethernet 1 interface and deactivated Ethernet 2 interface		60
Example with activation of both Ethernet interfaces		60
Fig.: Example of a successful connection test		61
Fig.: Example of an unsuccessful connection test		62
Fig.: Proxy settings		63
Fig.: Example - Transfer Test with an Error Image		65
Fig.: Example - Connection Test with an Error		65
Fig.: Export with deactivated encryption (switch is set to activated)		67
Fig.: Interface definition via the plus symbol		68
Fig.: Adding components		68
Fig.: Overview of the selected components		69
Fig.: Example - Interface selection between Solar-Log Base (Internal) and MOD 485 (Mod 485)		71
Fig.: Example - Interface selection MOD 485 and RS485		71
Fig.: Device detection - not started yet		72
Fig.: Direct marketing with imported example package		87
Fig.: Configuring the time on the Solar-Log™		96
Fig.: Solar-Log™ with license section		98
Fig.: Inverter details graph		102
Fig.: Tracker comparison graph		103
Fig.: Module field comparison graph		104
Fig.: Battery diagnosis - Current measurement values		105
Fig.: Battery diagnosis - Charging History 1-Day		106
Fig.: Battery diagnosis - Balance		108
Fig.: The event log is being loaded		109
Fig.: Feed-In Management - Control State		110
Fig.: Feed-In Management - Feed-balance		116
Fig.: PM History		117

Fig.: RS485 bus analysis with Janitza as an example (with installation mode active)	118
Fig.: Example segment section of the enlarged measured value range	119
Fig.: Example segment section of the lower measured value range.....	119
Fig.: Communication between the Solar-Log MOD I/O and Solar-Log Base.....	120
Fig.: Solar-Log MOD I/O - Solar-Log Base Communication bus/LEDs.....	120
Fig.: Communication between the Solar-Log MOD 485 and Solar-Log Base.....	122
Fig.: Solar-Log MOD 485 - Solar-Log Base Communication bus/LEDs.....	122
Fig.: Components - S0 meter on interface A and B	124
Fig.: Connection test - Wireless Package	125
Fig.: Example of the SCB string overview	126
Fig.: Smart Energy Status (current)	128
Fig.: Smart Energy History - Example of Priority 1	129
Fig.: Smart Energy - Simulation with AC-ELWA-E - Surplus Priority 1	131
Fig.: Support - General.....	133
Fig.: The plant's current values (cockpit view)	134
Fig.: Example of a plant with an energy flow.....	136
Fig.: Table with the recorded output from an example plant	137
Fig.: Graphic display of the plant's total production.....	138
Fig.: Daily View of the Production Graph with the Auto Scaling activated.....	139
Fig.: Day view of the production table.....	140
Fig.: Month view production graph.....	141
Fig.: Month view of the production table.....	142
Fig.: Year view graph.....	143
Fig.: Total view graph.....	144
Fig.: Graph of daily consumption with connected appliances in the sub-consumer view	148
Fig.: Graph of daily consumption with connected appliances and active line graphics in the sub-consumer view.....	149
Fig.: Day Balance graph with battery energy storage system	152
Fig.: Daily Balance Graph with the Auto Scaling activated.....	153
Fig.: Month view balance graph	154
Fig.: Year view balance graph	155
Fig.: Total balance graph	156
Fig.: Graph of Sensor Box values	157
Fig.: Example of a plant with an energy flow.....	159
Fig.: Wiring a ripple control receive with two relays - example 1.....	171
Fig.: Channel settings for active power reduction - example 1	172
Fig.: Wiring a ripple control receive with two relays - example 2.....	173
Fig.: Channel settings for active power reduction - example 2	174
Fig.: Wiring a ripple control receive with two relays - example 3.....	175
Fig.: Channel settings for active power reduction - example 3	176
Fig.: Wiring a ripple control receive with two relays - example 4.....	177
Fig.: Channel settings for active power reduction - example 4.....	178

Solar-Log GmbH
Fuhrmannstraße 9
72351 Geislingen-Binsdorf
Germany
Tel: +49 (0)7428/4089-300
info@solar-log.com
www.solar-log.com
www.solarlog-web.com

The copyright of these instructions remains with the manufacturer. No part of these instructions may be reproduced in any form or processed, duplicated or distributed using electronic systems without the written consent of Solar-Log GmbH.

Non-compliance resulting in contradiction of the above-mentioned specifications shall result in obligation to provide compensation for damages.

Subject to change without notice.

Solar-Log GmbH cannot guarantee the accuracy or completeness of the information provided and expressly refuses to accept liability for any errors or omissions in such information.

All brands and trademarks contained in this manual are the sole property of the respective manufacturer, which we respect and recognize herewith. In many countries, the designation "Speedwire" is a registered trademark of SMA Solar Technology AG.

Solar-Log GmbH assumes no liability for printing errors.